

TECH TECH CONTROLLERS

USER MANUAL

EU-427i

EN



www.tech-controllers.com

TABLE OF CONTENTS

1	Safety	4
2	Description of the control panel	5
2.1	Screen view– icons:.....	6
3	Principle of operation	6
4	Controller functions	7
4.1	Manual operation	7
4.2	Parameters P1/P2/P3.....	7
4.2.1	Operation type	7
4.3	Priorities	10
4.4	Programmes.....	10
4.5	Sensors	11
4.6	Pump operating time counter.....	11
4.7	Language selection.....	11
4.8	Information	11
5	Alarms	11
6	Fuse	11
7	Maintenance	12
8	Assembly	12
8.1	The diagram of connecting cables to the controller.....	12

1 SAFETY

Before using the device for the first time the user should read the following regulations carefully. Not obeying the rules included in this manual may lead to personal injuries or controller damage. The user's manual should be stored in a safe place for further reference. In order to avoid accidents and errors it should be ensured that every person using the device has familiarized themselves with the principle of operation as well as security functions of the controller. If the device is to be sold or put in a different place, make sure that the user's manual is there with the device so that any potential user has access to essential information about the device.

The manufacturer does not accept responsibility for any injuries or damage resulting from negligence; therefore, users are obliged to take the necessary safety measures listed in this manual to protect their lives and property.



WARNING

- **High voltage!** Make sure the regulator is disconnected from the mains before performing any activities involving the power supply (plugging cables, installing the device etc.)
- The device should be installed by a qualified electrician.
- Before starting the controller, the user should measure earthing resistance of the electric motors as well as the insulation resistance of the cables.
- The regulator should not be operated by children.



WARNING

- The device may be damaged if struck by a lightning. Make sure the plug is disconnected from the power supply during storm.
- Any use other than specified by the manufacturer is forbidden.
- Before and during the heating season, the controller should be checked for condition of its cables. The user should also check if the controller is properly mounted and clean it if dusty or dirty.

Changes in the merchandise described in the manual may have been introduced subsequent to its completion on 24.10.2022. The manufacturer retains the right to introduce changes to the structure. The illustrations may include additional equipment. Print technology may result in differences in colours shown.







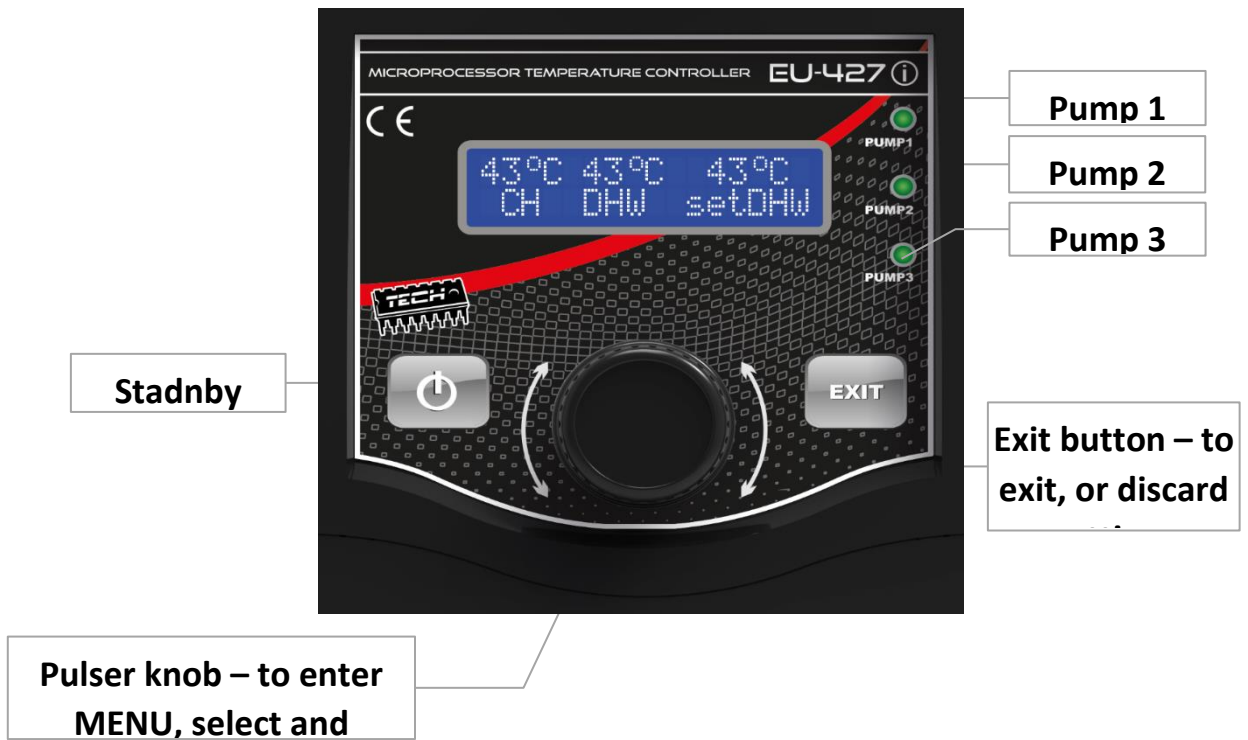





We are committed to protecting the environment. Manufacturing electronic devices imposes an obligation of providing for environmentally safe disposal of used electronic components and devices. Hence, we have been entered into a register kept by the Inspection For Environmental Protection. The crossed-out bin symbol on a product means that the product may not be disposed of to household waste containers. Recycling of wastes helps to protect the environment. The user is obliged to transfer their used equipment to a collection point where all electric and electronic components will be recycled.

2 DESCRIPTION OF THE CONTROL PANEL



2.1 SCREEN VIEW—ICONS:

-  gap between icons indicating pump and room controller status
-  pump operating in "sensor failure" mode
-  circulation pump
-  pump operating in "temperature mode"; turn-off threshold was reached
-  same as above but the turn-off threshold was not reached
-  pump operating in "temperature alarm mode"; alarm threshold was exceeded on one of the sensors
-  room controller open (too low temperature in the room)/pump operating in room mode
-  room controller closed (sufficient temperature in the room)/pump operating in room mode
-  pump operating in "anti-freezing mode"
-  pump operating in "anti-stop mode"

digit 1, 2 or 3 at the end of the pump operation symbol indicates the pump priority (only for "temperature" type)

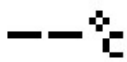
-  current temperature cannot be displayed (sensor error)

3 PRINCIPLE OF OPERATION

The intended use of EU-427i controller is to control the operation of max. 3 pumps at a time. The user can select one of the three pumps: central heating pump, domestic hot water pump or circulation pump. The controller turns the selected pump on or off depending on if the specific criteria are met.

The user can introduce changes in parameters using the **pulser knob**. The required function can be selected or the function value can be changed by turning the knob. By pressing the knob the function can be entered or the value can be changed. To exit any of the functions press the exit button.

The top line of the main screen indicates statuses of the pumps and the room controller while the bottom line shows the current temperatures on the individual sensors (unless they are off or damaged).

The controller is equipped with a system preventing extended periods of inactivity of pumps, a so-called *anti-stop* system. If the pump is not operating for a longer time period (e.g. in summer time) the pump is turned on for 1 minute at intervals equal to the number of days defined by the user. Additionally, the time is stored in a non-volatile memory to ensure that the time measurement is continued after any possible interruption in power supply.

The controller is also equipped with anti-freeze protection function to prevent water freezing in the circuit. If the pump sensor temperature drops below the value defined by the user (e.g. 7°C) the pump will turn on and operate until the sensor temperature is 2°C higher than the one defined by the user (which is 9°C in our example).

4 CONTROLLER FUNCTIONS

4.1 MANUAL OPERATION

By using this function the user can manually start any active actuator of the controller, independently from other actuators, and check the alarm operation. Pressing the **PULSER** turns the individual pumps on or off.

4.2 PARAMETERS P1/P2/P3

This function allows selecting parameters of P1, P2 or P3 pump to proceed to detailed settings of the pump operation.

4.2.1 Operation type

Here the type of the pump to be started should be defined. Depending on the operation selected further part of the menu is changed accordingly.

4.2.1.1 *Off*

This option is to be selected if no pump is connected to the input.

4.2.1.2 *Circulation*

By selecting this option the user will define the connection of the circulation pump to be operating in the defined time intervals with the possibility to set the turn-on threshold temperature.

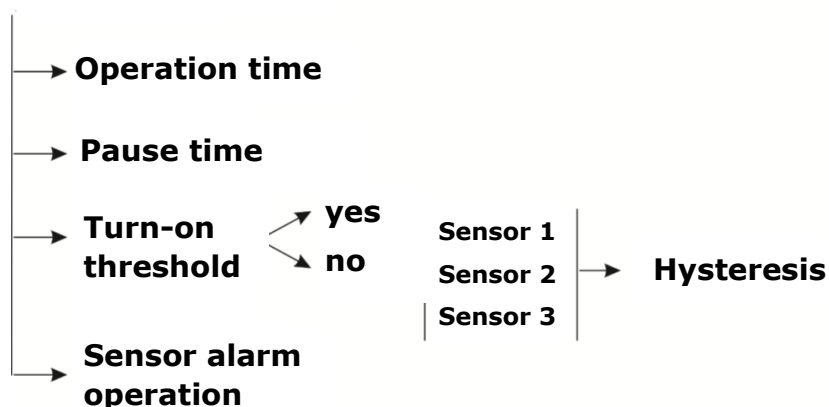

1. **Operation time** – allows defining working time of the circulation pump.
2. **Pause time** – allows defining time of pause in the circulation pump operation.
3. **Turn-on threshold** – allows setting the turn-on threshold temperature.

If the pump is to operate independently from the temperature, select **no** and confirm by pressing the pulser.

- If the circulation pump is to operate only above a preset temperature, select **yes** and confirm by pressing the pulser. Another step is to set the pump turn-on threshold using the pulser knob. Additionally, the user should define the sensor to provide current temperature for the pump.

4. **Sensor alarm operation** – allows defining if the pump operation should be triggered by an alarm of any of the sensors.

1. Turning-on

-**Turn-on sensor** – sensor should be defined to provide the pump with current temperature which will

Temperature operation

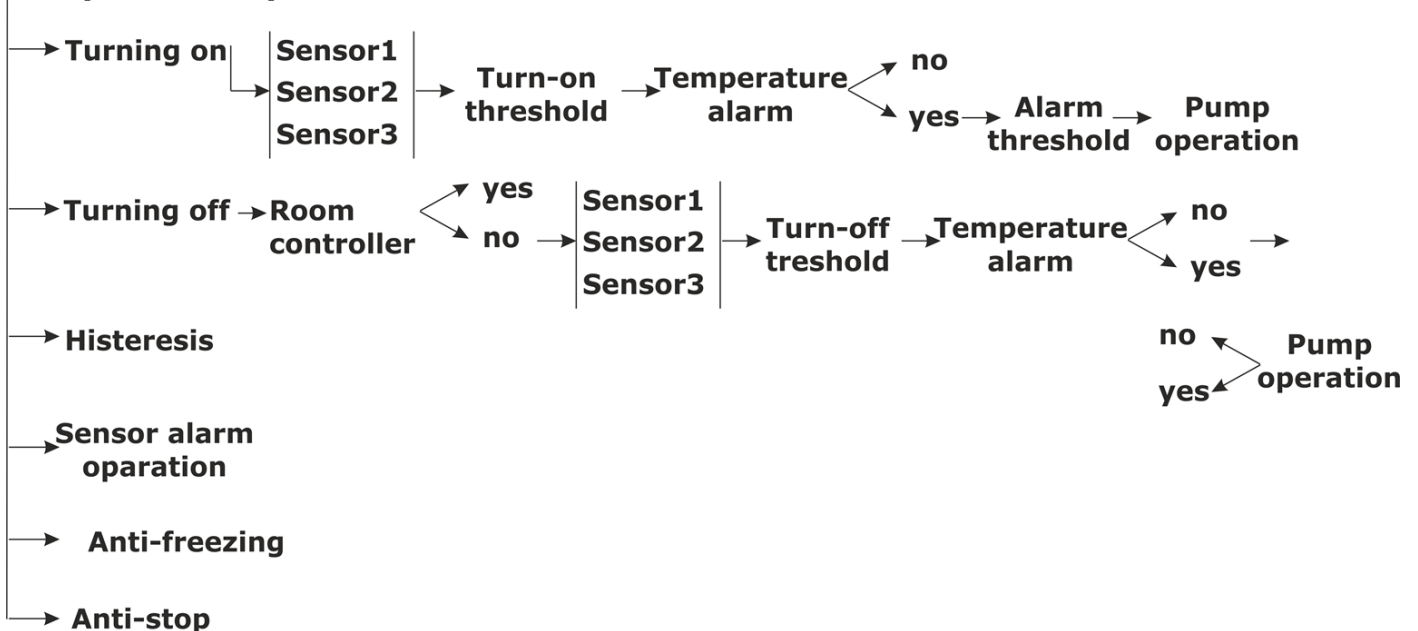

determine the pump turn-on threshold.

-**Turn-on threshold** – allows setting the turn-on threshold temperature; the pump will operate if the actual temperature exceeds the threshold value.

-**Temperature alarm** – the setting allows turning the temperature alarm function on or off. Once the option is selected the turn-on threshold temperature should be set and it needs to be indicated whether the pump will operate after the alarm is produced.

2. Turning-off

-**Room controller** – should the option be selected the pump will be turned off only after the room controller signal is received.

-**Turn-off sensor** - sensor should be defined to provide the pump with current temperature which will determine the pump turn-off threshold temperature

-**Turn-off threshold** - allows to set the turn-off threshold temperature

-**Temperature alarm** - the setting allows turning the temperature alarm function on or off. Once the option is selected the turn-on threshold temperature should be set and it needs to be indicated whether the pump will operate after the alarm is produced.

3. Hysteresis – applies to both turn-on threshold and turn-off threshold. The option is used to delay the controller response to temperature change when the temperature is fluctuating around the said thresholds.

4. Sensor alarm operation - allows defining if the pump operation should be triggered by an alarm of any of the sensors.

5. Anti-freezing - the setting allows turning the *anti-freezing* function on or off. Once the function is activated the anti-freezing threshold has to be defined i.e. the temperature below which the anti-freezing function is to be enabled.

6. Anti-stop - the setting allows turning the *anti-stop* function on or off. Once the function is activated the user needs to define the interval at which the pump will turn on (range: 1 - 30 days)

4.2.1.4 *Delta*

When connected in that mode the pump will operate based on the temperature difference between two selected sensors with the turn-on threshold on the source sensor and the turn-off threshold on the receiver (or a signal from the room controller). The following conditions have to be met for the pump to be operating: turn-on delta has been reached and the temperature difference is maintained above the turn-off delta

turn-on threshold temperature has been reached on the source sensor

temperature on the receiver sensor is maintained below the turn-off threshold or the room sensor indicates that the preset temperature has not been reached.

Temperature operation

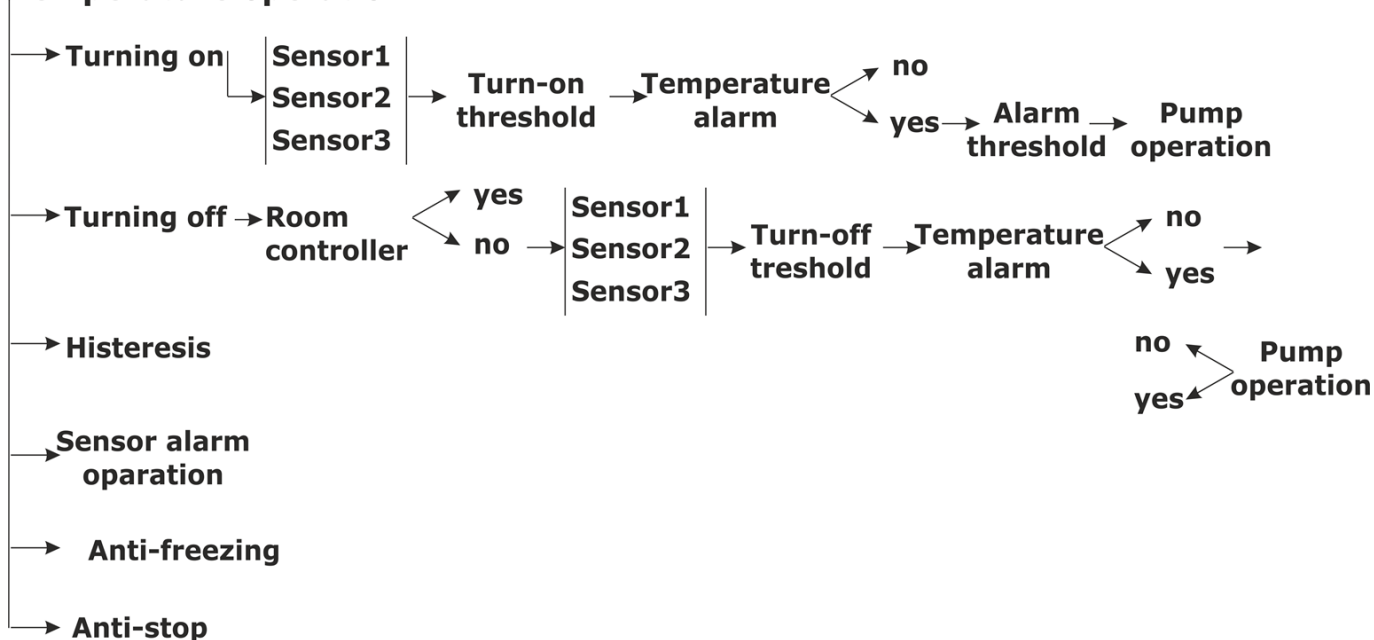

1. **Turn-on delta** – the option allows to define the temperature difference between two sensors (source sensor temperature less receiver sensor temperature) which, when reached, will turn the pump on.
2. **Turn-off delta** - the option allows defining the temperature difference between two sensors (source sensor temperature less receiver sensor temperature) below which the pump will turn off.
3. **Source**
 - **Sensor** – sensor should be defined to provide the source with current temperature.
 - **Turn-on threshold** – the option allows setting the temperature threshold for source activation i.e. the minimum temperature below which the pump will not turn on even if the remaining conditions are met.
 - **Temperature alarm**– the setting allows turning the temperature alarm function on or off. Once the option is selected the turn-on threshold temperature should be set and it needs to be indicated whether the pump will operate after the alarm is produced.
4. **Receiver**
 - **Sensor** – sensor should be defined to provide the receiver with current temperature value.
 - **Room controller** – the option allows turning the receiver pump off after it receives the signal from the room controller.
 - **Turn-off threshold** – the option allows setting the receiver turn-off threshold temperature.
 - **Temperature alarm**– the setting allows turning the temperature alarm function on or off. Once the option is selected the turn-on threshold temperature should be set and it needs to be indicated whether the pump will operate after the alarm is produced

5. **Hysteresis** - applies to both the turn-on threshold value (source) and turn-off threshold value (receiver). The option is used to delay the controller response to temperature change when the temperature is fluctuating around the said thresholds.
6. **Sensor alarm operation** - allows defining if the pump operation should be triggered by an alarm of any of the sensors.
7. **Anti-freezing** - the setting allows turning the *anti-freezing* function on or off. Once the function is activated the anti-freezing threshold value has to be defined i.e. the temperature below which the anti-freezing function is to be enabled.
8. **Anti-stop** - the setting allows turning the *anti-stop* function on or off. Once the function is activated the user needs to define the interval (in days) at which the pump will turn on.

4.2.1.5 Room controller operation

If connected in that mode the pump will operate according to the signal received from the room controller. When selecting that pump type it needs to be defined when the pump should turn on:

- **Pump operating with room controller in open state**

- **Pump operating with room controller in closed state**

4.3 PRIORITIES

Option available only for pumps operating in the temperature mode. It is possible to set operation priorities numbered 1 to 3 (the lower the number the higher the operation priority). It is used only if there are 2 or 3 pumps of the same type in the controller (the priority has no impact on other pumps).

Example: Setting of 1:2:2 denotes that pump1 will have priority over pump2 and pump3 which will operate simultaneously once the turn-off threshold of pump1 has been reached.

4.4 PROGRAMMES

The option allows setting predefined pump operation programmes:

Factory settings – The controller is pre-configured for operation. However, it should be adapted to individual needs. Factory settings can be restored at any time. Selection of “factory settings” option will result in all user pump settings being lost and reset to settings saved by the manufacturer. Individual pumps parameters can be set at that point again.

Central heating + domestic hot water – operation programme for two pumps. They are factory-set as parallel pumps but it is possible to set any priority for any of the pumps. Additionally, the following alarms are factory-set:

- after the temperature on sensor1 has reached 85°C the central heating pump will operate

- after the temperature on sensor2 has reached 85°C the domestic hot water pump will be turned off.

Central heating + domestic hot water + circulation – operation programme for three pumps. They are factory-set as parallel pumps but it is possible to set any priority for any of the pumps. Alarms are identical to those of programme1.

Central heating + domestic hot water + floor pump – operation programme for three pumps. They are factory-set as parallel pumps but it is possible to set any priority for any of the pumps. Alarms are identical to those of programme1.

User's – once that programme is selected all pumps are shut off – individual settings have to be entered.

Save user's settings – the option allows to save user's settings as an own programme.

Note: Loading of any programme will not affect the selected language, sensor types, operating time counters and saved counter indication until the next activation of the anti-stop function.

4.5 SENSORS

This option allows defining the type of the sensor connected:

- **none** – no sensor connected to the input – the sensor will not be selectable in all parameters.
- **KTY** – KTY-type temperature sensor connected to the input.
- **PT1000** – PT1000 temperature sensor connected to the input.

Note: If the user sets the sensor to “**none**” while it has been used in the operation of pumps, the pumps operating in temperature and delta modes will be shut off and the turn-on threshold will be deactivated for the pump working in circulation mode.

4.6 PUMP OPERATING TIME COUNTER

The function allows the user to preview the pump operating time counters to check numbers of days, hours and minutes of operation. The controller counts the seconds of operation of individual pumps and only after they add up to a full hour the controller stores the counter indication in the non-volatile memory. Therefore, any shut-off, power supply failure etc. occurring before 3600 seconds are counted will cause that, when restarted, the counter will indicate the number of full hours counted only. Pressing of pulser knob allows the user to reset the counter.

4.7 LANGUAGE SELECTION

The user may select the language version of the controller menus.

4.8 INFORMATION

Selection of this option provides access to the information about: software version, number of times the controller was started and the service centre telephone number. The screen is selected using the pulser. Service centre telephone number can be edited by pressing the pulser (there are 15 fields available to be filled with the following characters: 0-9 + - () space).

5 ALARMS

Each controller alarm is indicated with sound and a corresponding message displayed on the screen. Once the fault is rectified (or the circuit is cooled) the user can exit the alarm mode by pressing any button.

The alarms supported by the system are listed below in the order of priority:

1. No sensor 1/2/3

Message displayed: „Alarm. Sensor1/2/3”

2. Temperature on the sensor 1/2/3 above alarm threshold

Message displayed:”Temperature alarm. Sensor 1/2/3”

In the case of this alarm the pumps are turned on/off according to the individual pup settings.

6 FUSE

The controller is equipped with WT cylindrical fuse link 3.15 A to protect the network. Fuses of higher rating may result in controller damage.

7 MAINTENANCE

Before and during the heating season it is necessary to inspect the condition of cables inside **EU-427i** controller. Additionally, the controller fasteners needs to be checked and the controller should be cleaned to remove dust and other dirt. Also the efficiency of motor earthing should be measured.

Technical parameters of EU-427i controller

Power supply	230V ±10% /50Hz
Power consumption	4W
Ambient temperature	5÷50°C
Load on output of each pump	0,5A
Measurement accuracy	1°C
Thermal resistance of the sensor	-30÷99°C
Fuse	3.15A

8 ASSEMBLY

ATTENTION: The assembly should be done only by the person with proper qualifications! The device in this time must not be live (you should ensure that plug is disconnected from the grid)!

ATTENTION: wrong connection of wires can cause the damage of the regulator!

The regulator must not work in closed circuit of central heating. The balance tank, safety valves and pressure valves that protect by boiling the water in the central heating circuit must be mounted.

8.1 THE DIAGRAM OF CONNECTING CABLES TO THE CONTROLLER.

While assembly of wiring of the controller you should pay special attention to correct connecting ground wires.

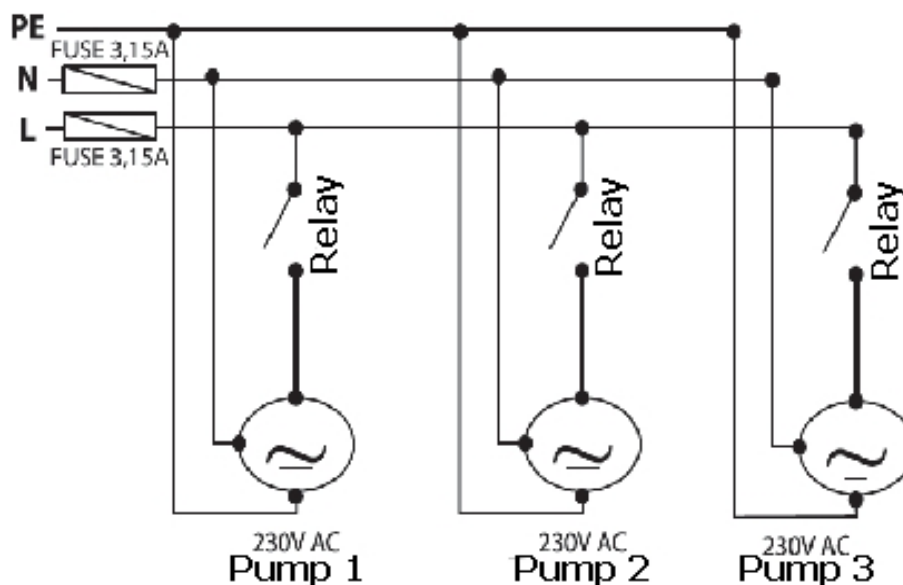

PE- earthing

N- neutral

L- phase

TECH CONTROLLERS

EU DECLARATION OF CONFORMITY

Hereby, we declare under our sole responsibility that **EU-427i** manufactured by TECH STEROWNIKI, head-quartered in Wieprz Biała Droga 31, 34-122 Wieprz, is compliant with Directive **2014/35/EU** of the European Parliament and of the Council of 26 February 2014 on the harmonisation of the laws of Member States relating to **the making available on the market of electrical equipment designed for use within certain voltage limits** (EU OJ L 96, of 29.03.2014, p. 357), **Directive 2014/30/EU** of the European Parliament and of the Council of 26 February 2014 on the harmonisation of the laws of Member States relating to **electromagnetic compatibility** (EU OJ L 96 of 29.03.2014, p.79), Directive **2009/125/EC** establishing a framework for the setting of ecodesign requirements for energy-related products as well as the regulation by the MINISTRY OF ENTREPRENEURSHIP AND TECHNOLOGY of 24 June 2019 amending the regulation concerning the essential requirements as regards the restriction of the use of certain hazardous substances in electrical and electronic equipment, implementing provisions of Directive (EU) 2017/2102 of the European Parliament and of the Council of 15 November 2017 amending Directive 2011/65/EU on the restriction of the use of certain hazardous substances in electrical and electronic equipment (OJ L 305, 21.11.2017, p. 8).

For compliance assessment, harmonized standards were used:

PN-EN IEC 60730-2-9:2019-06, PN-EN 60730-1:2016-10.

Paweł Jura

Janusz Master

Prezesa firmy

Wieprz, 24.10.2022

**TECH
TECH
CONTROLLERS**

Central headquarters:

ul. Biała Droga 31, 34-122 Wieprz

Service:

ul. Skotnica 120, 32-652 Bulowice

phone: **+48 33 875 93 80**

e-mail: **serwis@techsterowniki.pl**

www.tech-controllers.com