

TECH TECH CONTROLLERS

USER MANUAL EU-L-7E

EN



TABLE OF CONTENTS

I.	Safety	2
II.	Device description	4
III.	Installation	5
IV.	First start-up	6
V.	Main screen description	10
VI.	Controller functions	12
1.	Block diagram – controller menu	12
2.	Screen view	13
3.	Manual mode	13
4.	Zones	13
5.	Voltage-free contact	13
6.	Language selection	13
7.	Display contrast	13
8.	Fitter’s menu	13
9.	Software version	13
VII.	Zones	14
10.	Block diagram – zones menu	14
11.	OFF/ON	14
12.	Pre-set temperature	14
13.	Weekly control	14
14.	Operation mode	15
15.	Calibration	15
16.	Hysteresis	15
VIII.	Fitter’s menu	15
17.	Block diagram – fitter’s menu	15
18.	Valve	17
19.	Internet module	18
20.	TECH regulator	18
21.	Clock	18
22.	Set date	18
IX.	Own schedule settings	19
X.	Protections and alarms	21
XI.	Software update	21
XII.	Technical data	22

KN. 09.03.2022

*The pictures and diagrams are for illustration purposes only.
The manufacturer reserves the right to introduce some changes.*

I. SAFETY

Before using the device for the first time the user should read the following regulations carefully. Not obeying the rules included in this manual may lead to personal injuries or controller damage. The user's manual should be stored in a safe place for further reference. In order to avoid accidents and errors it should be ensured that every person using the device has familiarized themselves with the principle of operation as well as security functions of the controller. If the device is to be sold or put in a different place, make sure that the user's manual is there with the device so that any potential user has access to essential information about the device.

The manufacturer does not accept responsibility for any injuries or damage resulting from negligence; therefore, users are obliged to take the necessary safety measures listed in this manual to protect their lives and property.



WARNING

- **High voltage!** Make sure the regulator is disconnected from the mains before performing any activities involving the power supply (plugging cables, installing the device etc.).
- The device should be installed by a qualified electrician.
- Before starting the controller, the user should measure earthing resistance of the electric motors as well as the insulation resistance of the cables.
- The regulator should not be operated by children.



WARNING

- The device may be damaged if struck by a lightning. Make sure the plug is disconnected from the power supply during storm.
- Any use other than specified by the manufacturer is forbidden.
- Before and during the heating season, the controller should be checked for condition of its cables. The user should also check if the controller is properly mounted and clean it if dusty or dirty.

Changes in the merchandise described in the manual may have been introduced subsequent to its completion on 09.03.2022. The manufacturer retains the right to introduce changes to the structure. The illustrations may include additional equipment. Print technology may result in differences in colours shown.

Care for the natural environment is our priority. Being aware of the fact that we manufacture electronic devices obligates us to dispose of used elements and electronic equipment in a manner which is safe for nature. As a result, the company has received a registry number assigned by the Main Inspector of Environmental Protection. The symbol of a crossed out rubbish bin on a product means that the product must not be thrown out to ordinary waste bins. By segregating waste intended for recycling, we help protect the natural environment. It is the user's responsibility to transfer waste electrical and electronic equipment to the selected collection point for recycling of waste generated from electronic and electrical equipment.



II. DEVICE DESCRIPTION

EU-L-7E external controller is intended for controlling valves. The controller enables significant energy saving due to precise temperature management in particular rooms.

Thanks to advanced software the controller fulfils a wide range of functions:

- possibility of controlling thermostatic actuators via 8 room sensors (C-7p):
- one voltage contact for a 230V pump
- voltage-free contact (e.g. for controlling the heating device)
- voltage-free contact for controlling the pump operation algorithm (switching between heating and cooling)
- possibility of connecting ST-505 Internet or WiFi RS to control the system via the Internet
- possibility of connecting M-7 wireless control panel
- possibility of controlling the mixing valve (connecting ST-431N or i-1m valve module is necessary)
- possibility of updating the software via USB

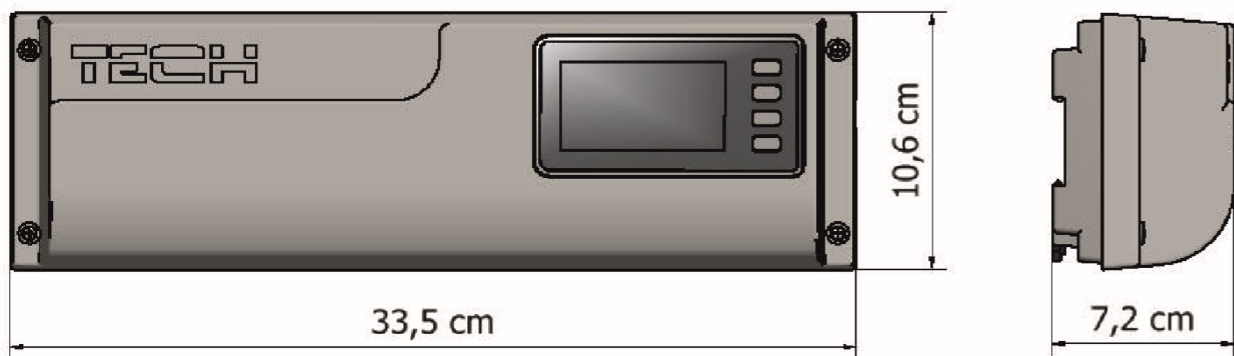

III. INSTALLATION

EU-L-7E controller should be installed by a qualified person.



WARNING

Risk of fatal electric shock from touching live connections. Before working on the controller switch off the power supply and prevent it from being accidentally switched on.



NOTE

Incorrect connection of wires may damage the controller.

WARNING

If pump manufacturer requires an external main switch, power supply fuse or additional residual current device selective for distorted currents it is recommended not to connect pumps directly to pump control outputs.

To avoid damaging to the device, an additional safety circuit must be used between the regulator and the pump. The manufacturer recommends the ZP-01 pump adapter, which must be purchased separately.

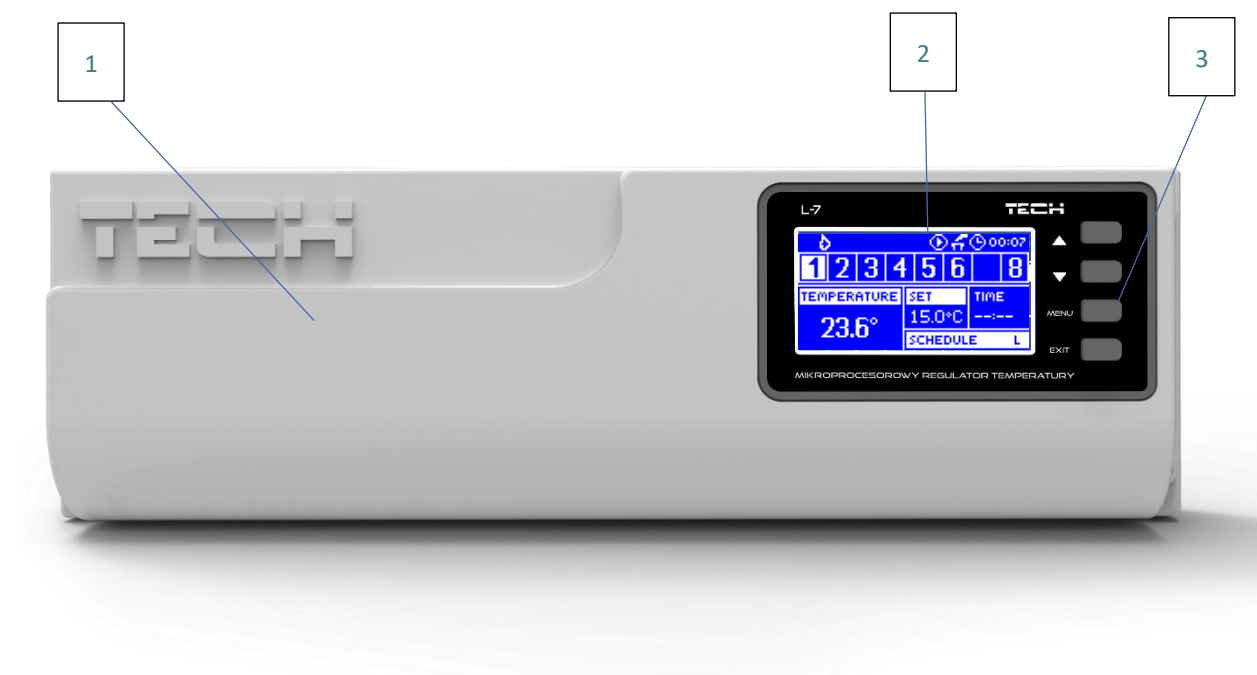

1. Controller cover (it needs to be removed before connecting the devices to be controlled)
2. Controller display
3. Navigation button



NOTE

The device is intended to be mounted on a DIN strip.



IV. FIRST START-UP

In order for the controller to operate correctly, the user must follow these steps when starting the device for the first time:

Step 1. Connect EU-L-7E controller with the devices

Remove the cover and connect the wires following the clues on the connectors and the diagrams presented below. Follow this order while connecting:

- all the necessary C-7p sensors (connectors 1-8)
- all the necessary valve actuators ST-230/2 (connectors 10-17)
- Internet module - via RS cable
- pump
- additional device (connector 18)
- heating / cooling device (connector 19)

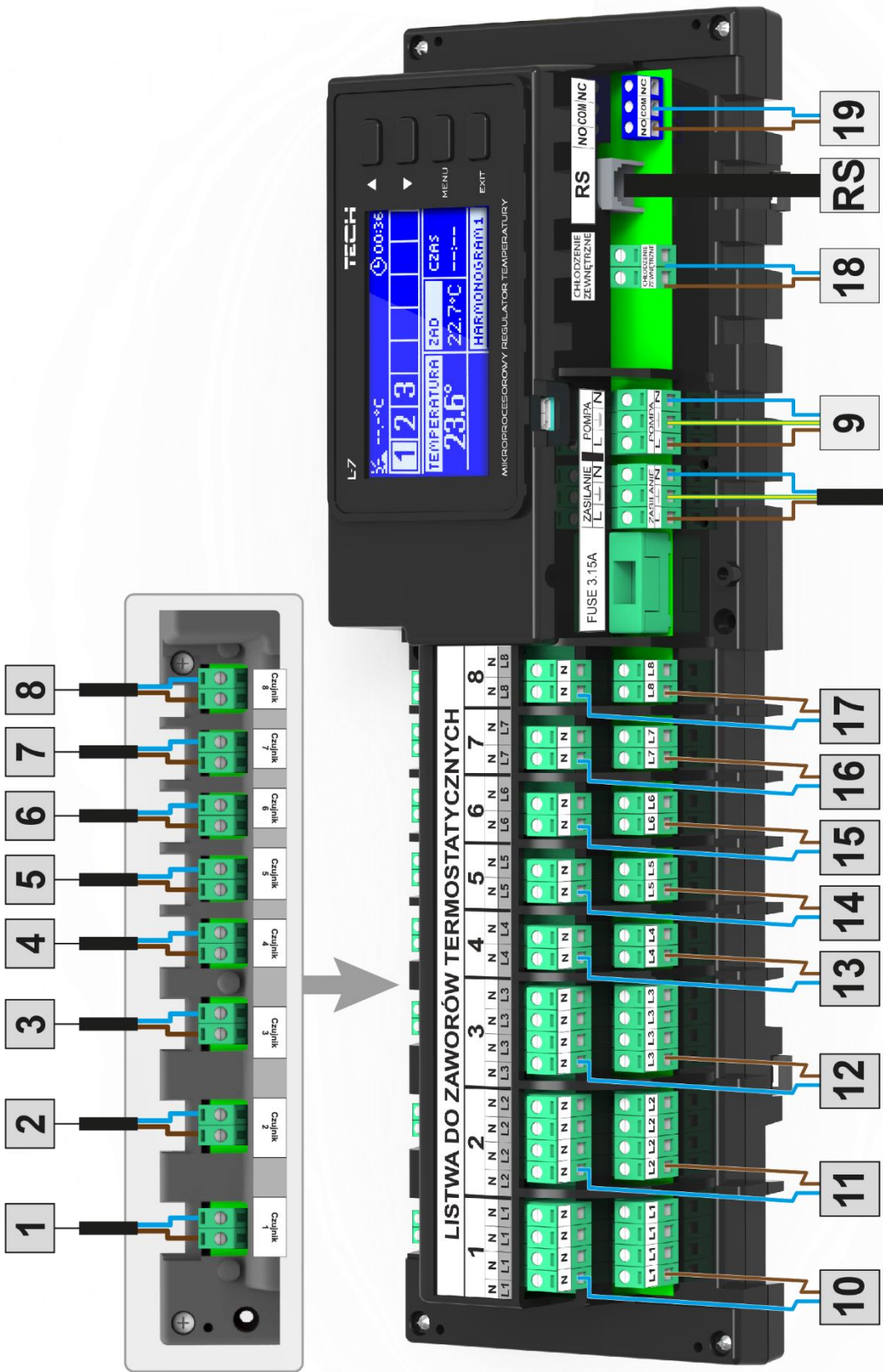

Pictorial diagram presenting wiring and communication with other devices in the system:

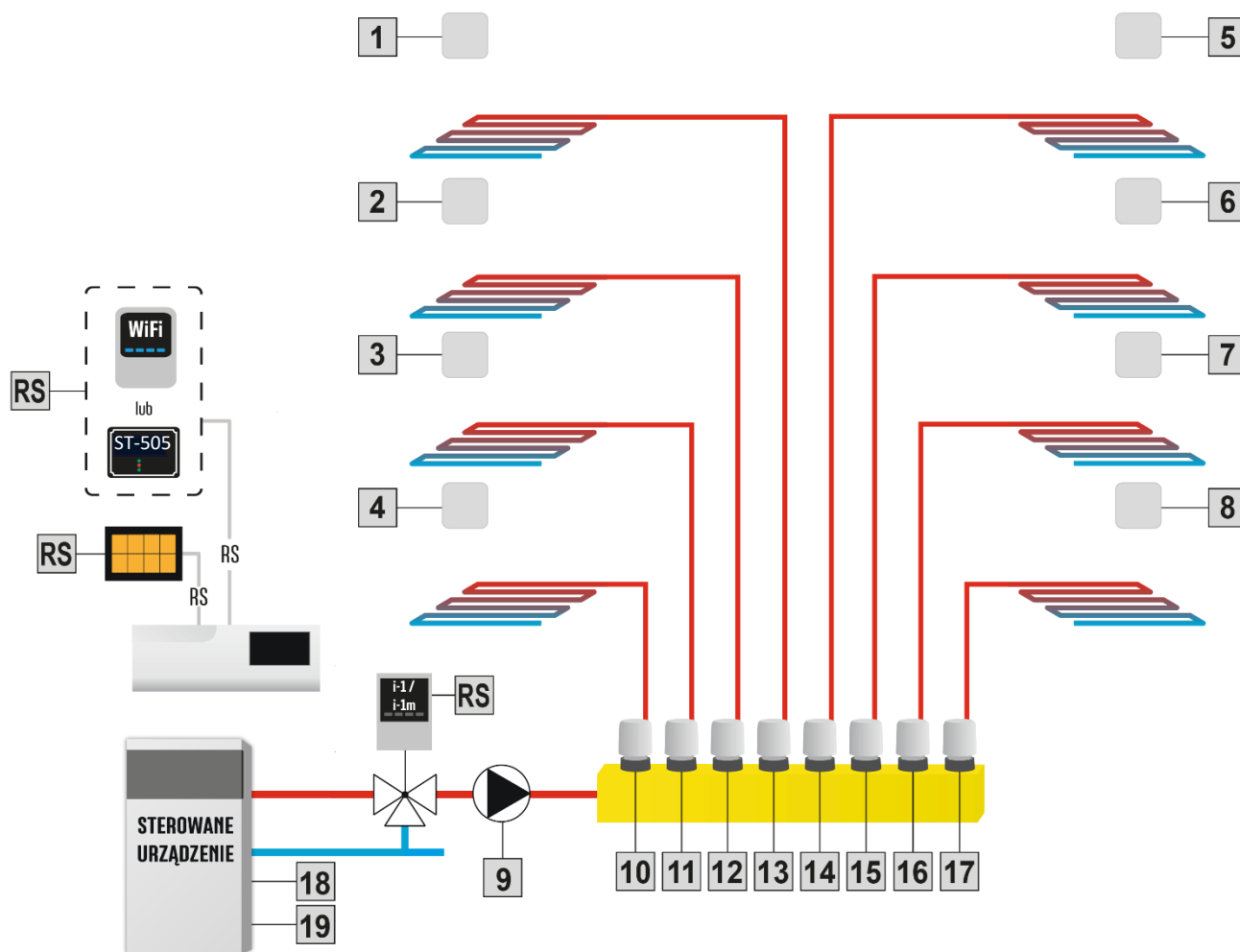

Step 2. Mounting electrolytic capacitors

In order to reduce the phenomenon of fluctuation in the temperature read from the zone sensor, use a 220uF / 25V low impedance electrolytic capacitor (GF 220U / 25V SAMXON) connected parallel to the sensor cable. When installing a capacitor, pay special attention to polarization. The ground of the element marked with a white stripe should be screwed into the right-hand side terminal of the sensor connector (looking at it from the front of the controller), which can be seen in the attached photographs. The second terminal of the capacitor should be screwed into the left-hand side terminal of the connector. So far the application of this solution has eliminated completely the occurring disturbances. It is worth noting, however, that the basic principle is proper connection of wires to avoid disruption. The cable should not be placed close to the sources of the electromagnetic field, but if this is the case, it is necessary to use a filter in the form of a capacitor.

Step 3. Switch on the power supply and check if the devices work

Once all the devices have been connected, switch on the power supply. Use manual mode to check if each device works - use buttons ▲ ▼ to select the device and press MENU button - the device should switch on. Follow this procedure to check all the devices.

Step 4. Activate the Internet module

EU-L-7E external controller is compatible with ST-505 Internet module and WiFi RS.

WiFi RS uses WiFi wireless network whereas ST-505 needs to be connected to a router with RJ45 network cable.



Connection diagram for ST-505 Internet module.

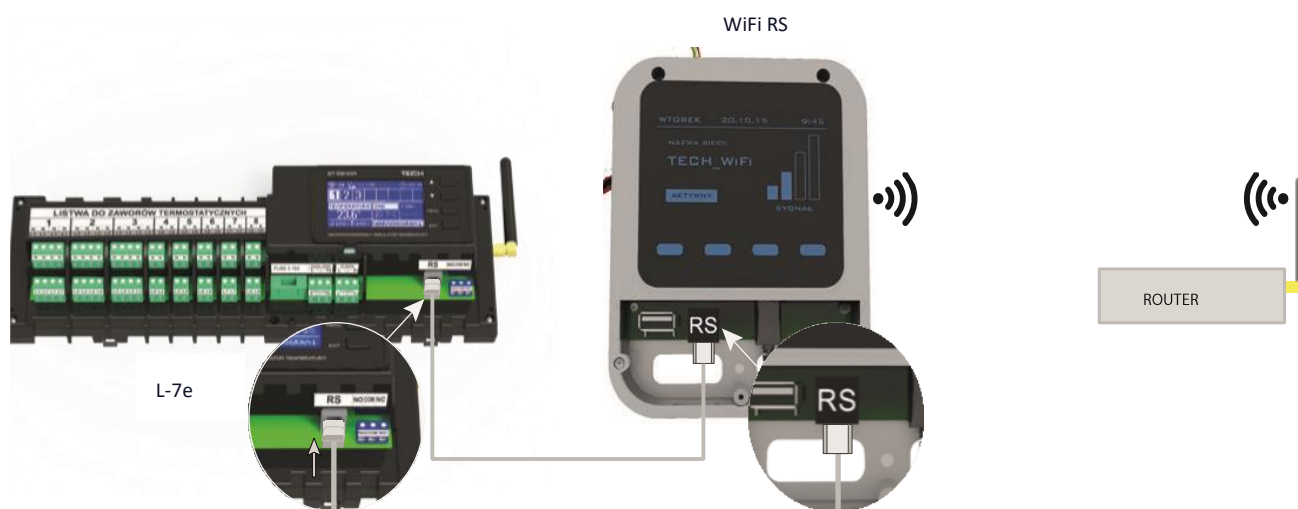

Connection diagram for WiFi RS Internet module.

ST-505 Internet module or WiFi RS should be connected as illustrated in the diagrams above. Next, activate the module in the controller menu: Main menu/Fitter's menu/Internet module/ON. Further steps are described in detail in the instruction manual for the Internet module.



NOTE

The user should enable the Internet module to connect with data servers listening on TCP/2000 port. Most computer networks are protected by various software (firewalls, anti-virus software etc.) which may block data exchange with the above mentioned port. If any problems arise, contact technical support or your computer network administrator.

Step 5. Set current time and date

Set current time and date in the fitter's menu.

Step 6. Configure the settings for temperature sensors, room regulators

To enable EU-L-7E to control a given zone, it is necessary to provide it with current temperature value. The easiest way is to use C-7p temperature sensor.

The user may also choose M-7 room regulator. It serves as a master controller enabling the user to change the pre-set temperatures in different zones, change the settings of the local and global weekly schedules etc. Only one room regulator of this type may be installed in the heating system.

- **C-7p room temperature sensor** – In order to activate the temperature sensor, use ON/OFF function in the submenu of a given zone (Zones > Zones 1-8 > ON/OFF). It is possible to set individual pre-set temperature value and weekly schedule for each room sensor assigned to a given zone. The settings may be configured both in the controller menu (Main menu/Zones) and via www.emodul.eu (using ST-505 or WiFi RS module).
- **M-7 room regulator (control panel)** – In order to activate M-7 room regulator (control panel), connect it to EU-L-7E controller using RS cable and select <ON> in the external controller menu (Fitter's menu > TECH regulator).

V. MAIN SCREEN DESCRIPTION

The user navigates in the menu structure using the buttons located next to the display.

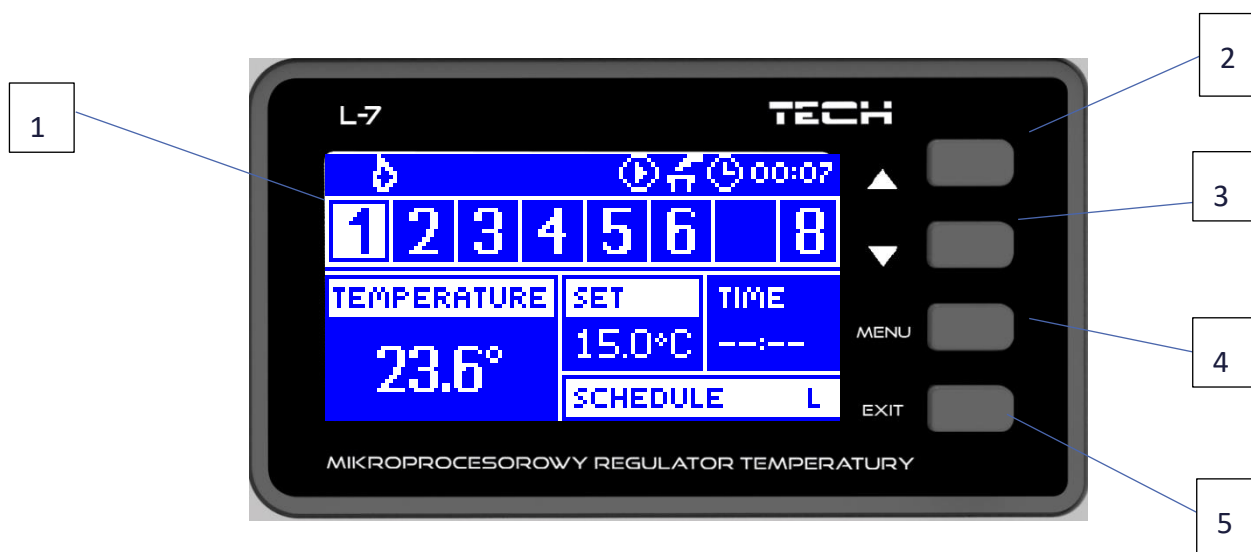

1. Display.
2. ▲ - 'up', 'plus' – it is used to view the menu options and increase the value while editing parameters. During standard operation the button is used to switch between parameters of different zones.
3. ▼ - 'down', 'minus' - it is used to view the menu options and decrease the value while editing parameters. During standard operation the button is used to switch between parameters of different zones.
4. MENU button – it is used to enter the controller menu and confirm the new settings.
5. EXIT button – it is used to exit the menu and cancel the settings

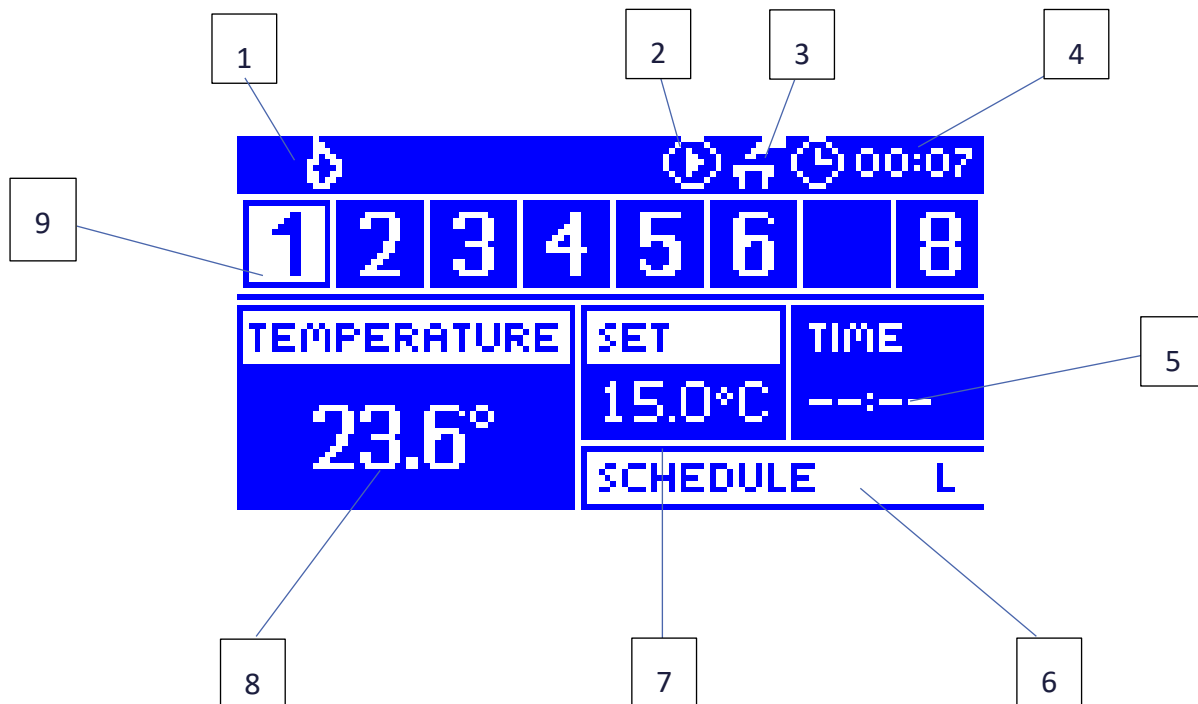

1. Current mode (flame– heating, snowflake – cooling)
2. An icon indicating pump operation
3. Voltage-free contact
4. Current time
5. Time left until the manually set temperature in a given zone changes
6. Information about the type of current weekly schedule
7. Pre-set temperature in a given zone (backlit number in the zone bar – see: description no. 9)
8. Current temperature of C-7p sensor in a given zone (backlit number in the zone bar – see: description no. 9)
9. Zone information:

- The digit displayed indicates that the corresponding room sensor is connected and sends current temperature information. If the zone temperature is too low, the digit flashes. In the event of a zone alarm, an exclamation mark is displayed instead of the digit.
- In order to view the operation parameters of a given zone, select its number using ▲ or ▼ .

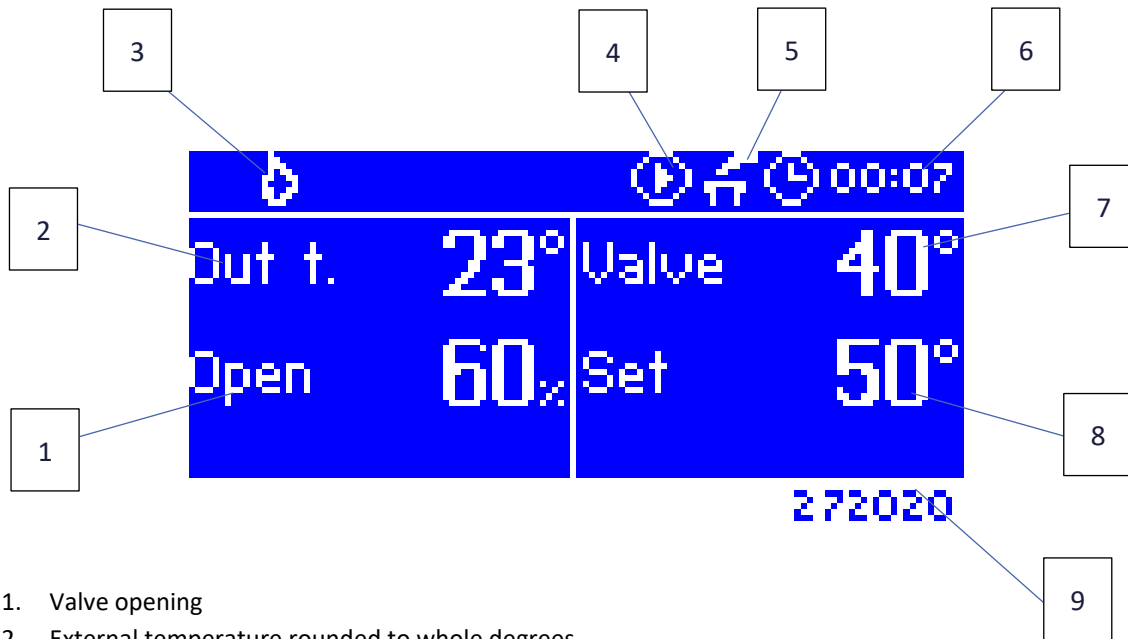

1. Valve opening
2. External temperature rounded to whole degrees
3. Current mode (flame– heating, snowflake – cooling)
4. An icon indicating pump operation
5. Voltage-free contact
6. Current time
7. Current valve temperature
8. Pre-set valve temperature
9. Individual valve address (used for registration purpose)

VI. CONTROLLER FUNCTIONS

1. BLOCK DIAGRAM – CONTROLLER MENU

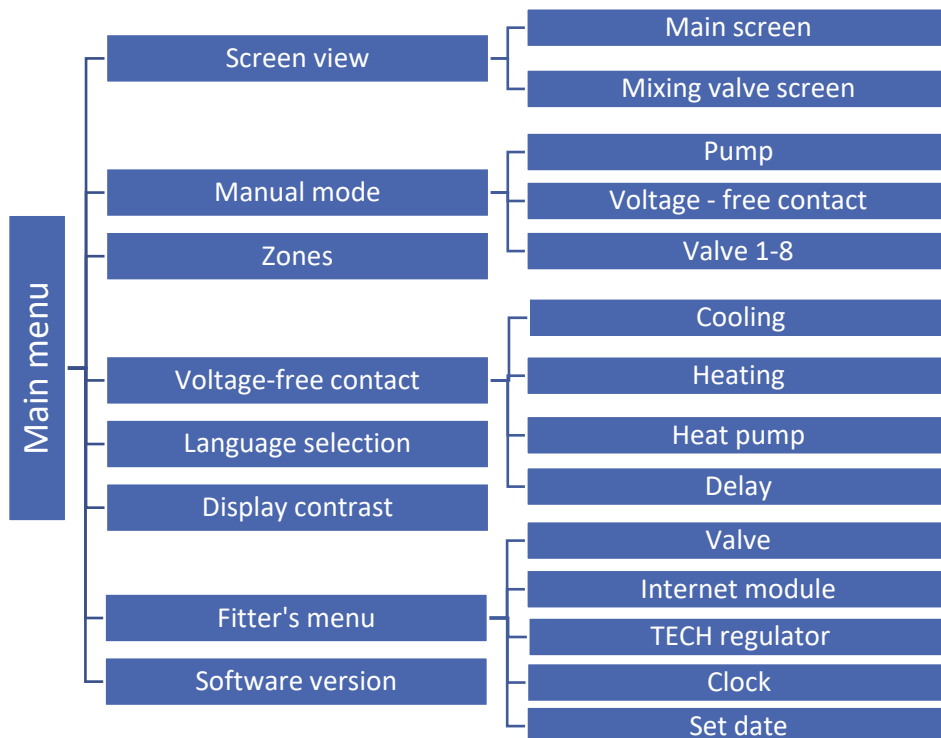

2. SCREEN VIEW

In this submenu the user may change the main screen view:

- Main screen – including zones parameters e.g. pre-set temperature, current temperature etc.
- Mixing valve screen – including mixing valve operation parameters.

3. MANUAL MODE

This function enables the user to activate particular devices (pump, voltage-free contact and valve actuators) independently of the others in order to check if they operate properly. It is advisable to check the devices using this procedure at the first start-up.

4. ZONES

This menu is described in detail in section VII.

5. VOLTAGE-FREE CONTACT

- **Cooling** – Once this function has been selected, the voltage-free contact will enable/disable cooling.
- **Heating** – Once this function has been selected, the voltage-free contact will enable/disable heating.
- **Heat pump** – Once this function has been selected, the voltage-free contact will enable/disable heating or cooling depending on the status of the contact input.
- **Delay** – This function enables the user to define the activation delay for the device connected to the voltage-free contact. If cooling or heating is needed, the heating or cooling mode will be enabled after the pre-set delay time.

6. LANGUAGE SELECTION

This function is used to select the language version of the controller menu.

7. DISPLAY CONTRAST

This function is used to adjust the display contrast to individual needs.

8. FITTER'S MENU

Fitter's menu is described in section VIII.

9. SOFTWARE VERSION

When this option is selected, the display shows the manufacturer's logo and the controller software version.

VII. ZONES

10. BLOCK DIAGRAM – ZONES MENU

This submenu enables the user to configure operation parameters for particular zones.

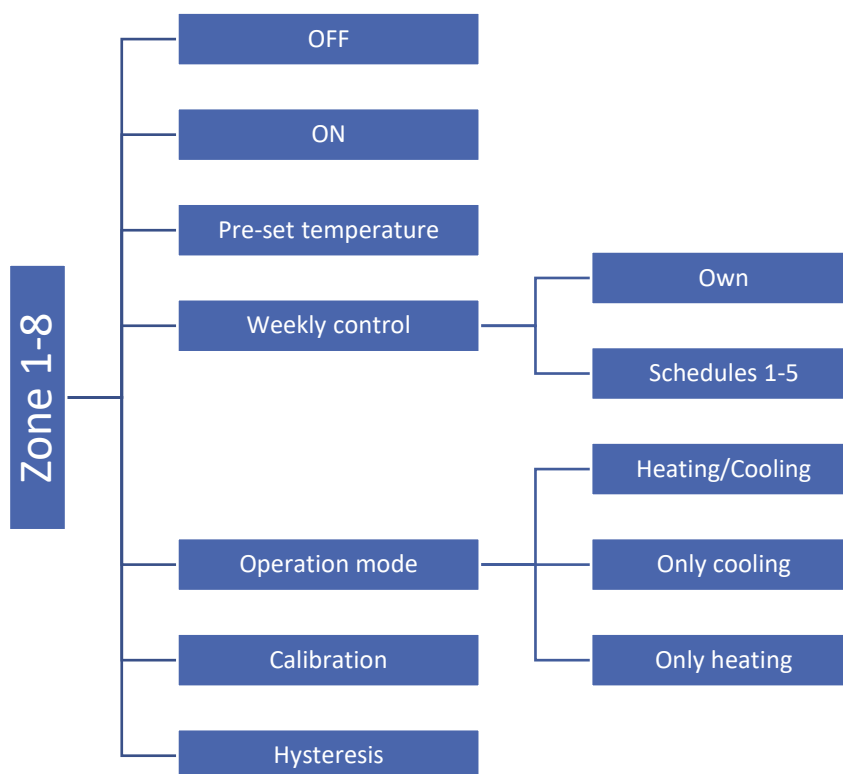

11. OFF/ON

After the room sensor has been connected and registered in a given zone, it is used by EU-L-7E controller. The default setting for this option is <OFF>. It may be activated when the room sensor has been connected.

12. PRE-SET TEMPERATURE

The pre-set zone temperature depends on the weekly schedule settings. However, this function enables the user to change this value separately. After the value has been set, the user defines how long the temperature should apply. When the time elapses, the pre-set temperature will depend on the weekly schedule again.

After pressing MENU button in this submenu, the display shows application time screen (permanent, temporary).

The main screen displays current pre-set temperature value and the time left (see: Main screen description).

13. WEEKLY CONTROL

EU-L-7E controller offers two types of weekly schedules:

Own – local schedule

This weekly schedule is assigned to a given zone only. After the room sensor has been detected by the external controller, the schedule is activated automatically in this zone and may be adjusted by the user to individual needs.

Schedule 1-5 – global schedule

These schedules have universal settings for all zones and they cannot be edited in the external controller (to introduce changes it is necessary to use M-7 control panel or connect to the Internet via the Internet module).

In order to assign a schedule to a given zone, choose *Select* option.

In order to adjust the global schedule as the current schedule in a given zone, choose *Edit* option. After the schedule has been modified and saved, it is overwritten as a local schedule.

The type of weekly schedule assigned to a given zone is displayed in the main screen (See: Main screen description – screen area no. 6).

14. OPERATION MODE

This option enables the user to exclude a given zone from certain operation algorithm:

- **Heating/cooling** – when this option is selected, a given zone is not excluded from any operation algorithm (heating, cooling).
- **Only heating** – a given zone is active only in heating mode.
- **Only cooling** – a given zone is active only in cooling mode.

15. CALIBRATION

Room sensor calibration should be performed while mounting or after it has been used for a long time, if the external temperature displayed differs from the actual temperature. Calibration setting range is from -10 to +10°C with the accuracy of 0,1°C.

16. HYSTERESIS

This function is used to define tolerance of the pre-set temperature in order to prevent undesired oscillation in case of small temperature fluctuation (within the range 0 ÷ 15°C) with the accuracy of 0,1°C.

Example: if the pre-set temperature is 23°C and the hysteresis is 0,5°C, the zone temperature is considered too low when it drops to 22,5°C.

VIII. FITTER'S MENU

Fitter's menu should be accessed by a qualified person. It enables the user to configure additional functions of the controller.

17. BLOCK DIAGRAM – FITTER'S MENU

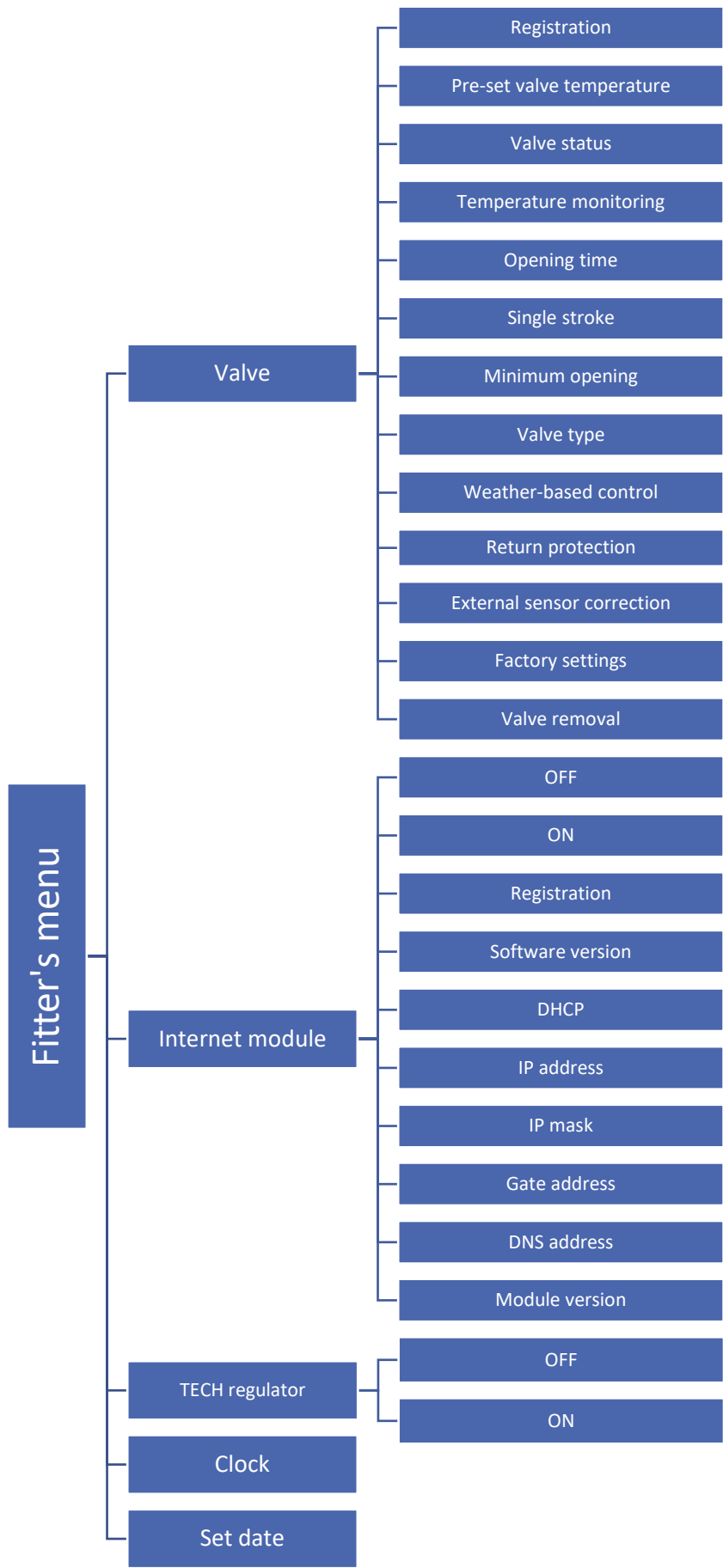

18. VALVE

EU-L-7E external controller may control an additional valve via valve module (e.g. ST-431N). The devices communicate using RS communication but it is necessary to register first.

- **Registration** - Configuring particular parameters of additional valve is possible only after it has been properly registered by entering the module number (the number may be found at the back of the control module cover or in Software version submenu).
- **Pre-set valve temperature** - This function is used to define the pre-set valve temperature measured by the valve sensor.
- **Valve status** - This function is used to deactivate the valve temporarily. The valve may be activated again without the need to register it again.
- **Temperature monitoring** - This parameter determines the frequency of water temperature measurement (control) behind the CH valve. If the sensor indicates a change in temperature (deviation from the pre-set value), the electric valve will open or close by the pre-set stroke, in order to return to the pre-set temperature.
- **Opening time** - This parameter defines the time needed for the valve actuator to open the valve from 0% to 100% position. This value should be adjusted to the value given on the actuator rating plate.
- **Single stroke** - This is the maximum single stroke (opening or closing) that the valve may make during one temperature sampling. The smaller the single stroke, the more precisely the set temperature can be achieved. However, it takes longer for the set temperature to be reached.
- **Minimum opening**- The parameter determines the smallest valve opening. Thanks to this parameter, the valve may be opened minimally, to maintain the smallest flow.
- **Valve type** - this option is used to select the valve type:
 - **CH** - select this option if you want to control CH circulation temperature.
 - **FLOOR** - select this option if you want to control the floor heating temperature. It protects the underfloor heating installation against dangerous temperature. If the user selects CH as the valve type and connects it to the underfloor heating system, the fragile floor installation may be damaged.
- **Weather-based control** - For the function of weather control to be active, the external sensor mustn't be exposed to sunlight or influenced by the weather conditions. After it has been installed in an appropriate place, weather control function needs to be activated in the controller menu.

In order for the valve to operate correctly, the user defines the pre-set temperature (downstream of the valve) for 4 intermediate external temperatures: -20°C, -10°C, 0°C and 10°C. In order to configure the pre-set temperature value, use arrows UP and DOWN to select particular external temperature and use arrows UP and DOWN to set desired temperature value.

Heating curve – it is a curve according to which the pre-set controller temperature is determined, on the basis of external temperature. In our controller, this curve is constructed on the basis of four pre-set temperatures for respective values of external temperatures.

The more points constructing the curve, the greater its accuracy, which allows its flexible shaping. In our opinion, four points seem a very good compromise ensuring decent accuracy and easiness of setting the course of this curve.



NOTE

Once weather-based control has been activated, *Pre-set valve temperature* parameter is not available (Main menu --> Fitter's menu --> Valve --> Pre-set valve temperature).

- **Return protection** - This function enables the user to set boiler protection against too cool water returning from the main circulation, which could cause low-temperature boiler corrosion. The return protection involves closing the valve when the temperature is too low, until the short circulation of the boiler reaches an appropriate temperature level. Once it is activated, the user presets the minimum acceptable return temperature.
- **External sensor correction** - External sensor correction should be performed during installation or after a longer period of using the regulator when the temperature measured by the sensor is different from actual temperature. Range of regulation is -10 to +10 °C with the accuracy of 0,1°C.
- **Factory settings** - This parameter is used to restore the factory settings of a given valve.
- **Valve removal** - This option is used to remove the valve from the controller memory. Valve removal is used e.g. at disassembling the valve or module replacement (re-registration of a new module is necessary).

19. INTERNET MODULE

Internet module is a device enabling the user remote control of the regulator. The user may control the status of all system devices on the home computer screen, tablet or smart phone and adjust certain parameters via the Internet.

After switching the module on and selecting DHCP option, the controller automatically downloads such parameters as IP address, IP mask, gateway address and DNS address from the local network.

The Internet module may be connected to EU-L-7E via RS cable. Detailed description of the procedure is available in the Internet module instruction manual.

INSTALLER MENU

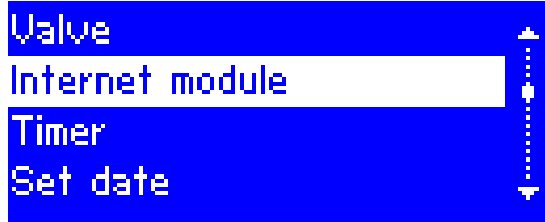

INTERNET MODULE

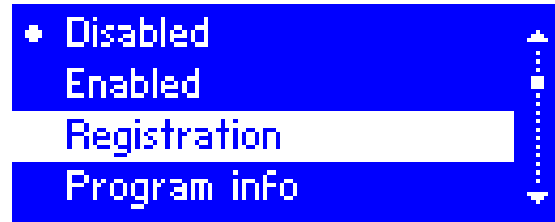

NOTE

This type of control is available only after purchasing and connecting an additional controlling module ST-505 or WiFi RS which is not included in the standard controller set.

20. TECH REGULATOR

Once <ON> option has been selected, M-7 regulator will be used by the external controller. The default setting for this option is <OFF>. It may be activated when the room sensor has been registered and connected to the external controller.

21. CLOCK

This function is used to set current time.

22. SET DATE

This function is used to set date.

IX. OWN SCHEDULE SETTINGS

Once the schedule has been selected (Menu -> Zones -> Zone 1-8 -> Weekly control), the user may select, view and edit a given schedule.

Schedule view screen:

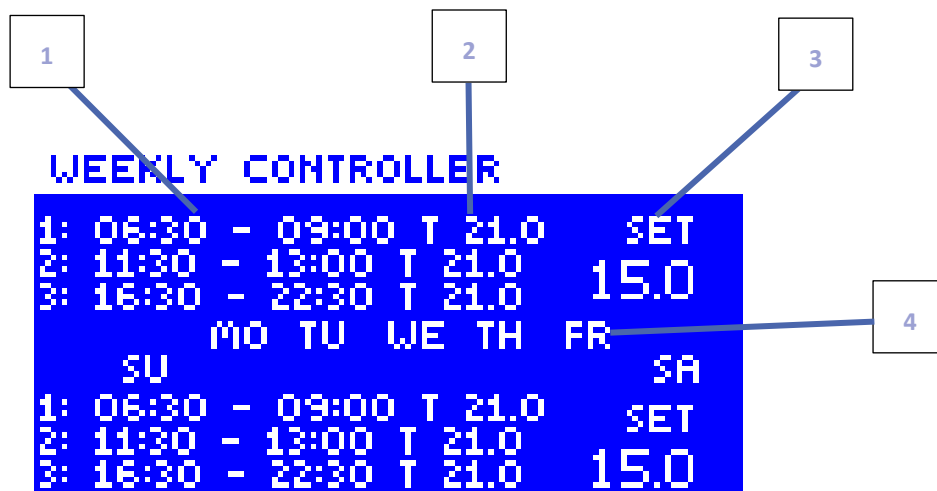

1. Time periods.
2. Pre-set temperature for time periods.
3. Pre-set temperature outside time periods.
4. Days when the above settings will apply.



NOTE

The user may program 3 different time periods in a given schedule (with the accuracy of 15 minutes).



NOTE

Only own schedule (for a given zone) may be edited from the external controller. Global schedules 1-5 may be edited only from M-7 control panel or Internet module (WIFI RS or ST-505).

Follow these steps to configure the schedule:

- Use arrows UP and DOWN to set the starting time for the first time period. Press MENU to confirm.
- Use arrows UP and DOWN to set the finishing time for the first time period. Press MENU to confirm.



- Use arrows UP and DOWN to define the pre-set temperature for the first time period. Press MENU to confirm.

SCHEDULE



- Once the time periods are ready, use arrows UP and DOWN to define the pre-set temperature which will apply outside these periods. Press MENU to confirm.

SCHEDULE



- Select the days when a given schedule will apply. Use UP arrow to switch between days and DOWN arrow to select the days. Selected days will be highlighted in white. Press MENU to confirm.

When the schedules for all days are ready, confirm the settings by pressing MENU. Active option will be highlighted in white.

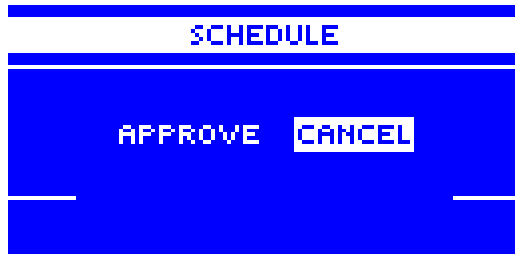

X. PROTECTIONS AND ALARMS

In order to ensure safe and failure-free operation, the regulator has been equipped with a range of protections. In case of an alarm, a sound signal is activated and the display shows a message informing about the detected problem.

Automatic sensor control

In the event of temperature sensor damage an alarm is activated informing the user about the type of failure e.g. 'Alarm. Sensor damaged'.

The alarm remains active until the problem is solved (checking the sensor connection) or the alarm is deleted from the external controller level.

How to delete the alarm in the external controller

Select the zone where the alarm has occurred (an exclamation mark is displayed instead of the external controller number). Press EXIT - the screen will display two options: Reset and OFF.

The external controller will attempt to communicate with the sensor (it may take a few minutes). The valve remains in alarm position until the communication is established. If the communication attempt is not successful, the alarm will be activated again.

OFF

This function is used to deactivate the zone. The zone may be activated again with ON option - Main menu / Sensors / Zone 1...8.

This alarm may also be deleted via the website.

Fuse

The regulator has a WT 6,3A tube fuse-link (5x20mm) protecting the network.



WARNING

Higher amperage fuse should not be used as it may damage the controller.

XI. SOFTWARE UPDATE

In order to install new software, the controller must be unplugged from the power supply. Next, insert the USB flash drive with the new software into the USB port. Connect the controller to the power supply at the same time holding EXIT button. It is necessary to hold EXIT button until a single sound signal is heard – it signals that the software update process has been initiated. After it has been completed, the controller restarts automatically.



NOTE

Software update shall be conducted only by a qualified fitter. After the software has been updated, it is not possible to restore previous settings. Do not switch the controller off while updating the software.

XII. TECHNICAL DATA

Power supply	230V +/-10% / 50Hz
Maximum power consumption	7W
Ambient working temperature	5÷50°C
Potential contacts 1-8 max. output load	0,3 A
Pump max. output load	0,5 A
Potential-free cont. nom. out. load	230V AC / 0,5A (AC1) * 24V DC / 0,5A (DC1) **
Thermal resistance of sensors	-30°÷50°C
Fuse link	6,3 A

* AC1 load category: single-phase, resistive or slightly inductive AC load.

** DC1 load category: direct current, resistive or slightly inductive load.

TECH TECH CONTROLLERS

EU Declaration of conformity

Hereby, we declare under our sole responsibility that **EU-L-7e** manufactured by TECH STEROWNIKI II Sp. z o.o., headquartered in Wieprz Biała Droga 31, 34-122 Wieprz, is compliant with Directive **2014/35/EU** of the European Parliament and of the Council of 26 February 2014 on the harmonisation of the laws of Member States relating to **the making available on the market of electrical equipment designed for use within certain voltage limits** (EU OJ L 96, of 29.03.2014, p. 357), **Directive 2014/30/EU** of the European Parliament and of the Council of 26 February 2014 on the harmonisation of the laws of Member States relating to **electromagnetic compatibility** (EU OJ L 96 of 29.03.2014, p.79), Directive **2009/125/EC** establishing a framework for the setting of ecodesign requirements for energy-related products as well as the regulation by the MINISTRY OF ENTREPRENEURSHIP AND TECHNOLOGY of 24 June 2019 amending the regulation concerning the essential requirements as regards the restriction of the use of certain hazardous substances in electrical and electronic equipment, implementing provisions of Directive (EU) 2017/2102 of the European Parliament and of the Council of 15 November 2017 amending Directive 2011/65/EU on the restriction of the use of certain hazardous substances in electrical and electronic equipment (OJ L 305, 21.11.2017, p. 8).

For compliance assessment, harmonized standards were used:

PN-EN IEC 60730-2-9:2019-06, PN-EN 60730-1:2016-10, PN EN IEC 63000:2019-01 RoHS.

Wieprz, 09.03.2022

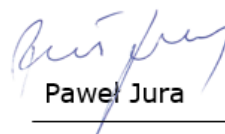
Pawel Jura

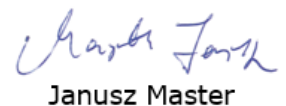
Janusz Master

Prezisi firmy

**TECH
TECH
CONTROLLERS**

Central headquarters:

ul. Biała Droga 31, 34-122 Wieprz

Service:

ul. Skotnica 120, 32-652 Bulowice

phone: **+48 33 875 93 80**

e-mail: **serwis@techsterowniki.pl**

www.tech-controllers.com