

TECH TECH CONTROLLERS

USER MANUAL

EU-297 v3

EN



www.tech-controllers.com

CONTENTS

I.	Safety	3
II.	Device description	4
III.	How to install the controller	5
1.	Installation of the regulator - batteries	6
2.	Installation of the regulator – power supply 230V	7
IV.	First start-up	10
V.	How to use the controller	10
1.	Principle of operation	10
2.	Operation modes.....	10
VI.	Device description	11
1.	Main screen description	12
VII.	Controller functions	12
1.	Block diagram - main menu.....	13
1.1.	Clock	13
1.2.	Operation mode	13
1.3.	Constant pre-set temperature.....	14
1.4.	Pre-set day temperature	14
1.5.	Day from... ..	14
1.6.	Pre-set night temperature.....	14
1.7.	Night from.....	14
1.8.	Hysteresis.....	15
1.9.	Floor heating ON/OFF.....	15
1.10.	Button lock ON/OFF.....	16
2.	Menu button functions	16
2.1.	Cooling/heating	16
2.2.	Built-in sensor calibration.....	17
2.3.	Floor sensor calibration	17
2.4.	Software version.....	17
2.5.	Default settings.....	17
VIII.	Technical data	18

I. SAFETY

Before using the device for the first time the user should read the following regulations carefully. Not obeying the rules included in this manual may lead to personal injuries or controller damage. The user's manual should be stored in a safe place for further reference.

In order to avoid accidents and errors, it should be ensured that every person using the device has familiarized themselves with the principle of operation as well as security functions of the controller. If the device is to be sold or put in a different place, make sure that the user's manual is stored with the device so that any potential user has access to essential information about the device.

The manufacturer does not accept responsibility for any injuries or damage resulting from negligence; therefore, users are obliged to take the necessary safety measures listed in this manual to protect their lives and property.

WARNING



- High voltage! Make sure the regulator is disconnected from the mains before performing any activities involving the power supply (plugging cables, installing the device etc.)
- The device should be installed by a qualified electrician.
- The regulator should not be operated by children.

WARNING



- The device may be damaged if struck by a lightning. Make sure the plug is disconnected from the power supply during storm.
- Any use other than specified by the manufacturer is forbidden.
- It is recommended to periodically check the condition of the device.

Changes in the merchandise described in the manual may have been introduced subsequent to its completion on 30.11.2022. The manufacturer retains the right to introduce changes to the structure or colours. The illustrations may include additional equipment. Print technology may result in differences in the colours shown.



We are committed to protecting the environment. Manufacturing electronic devices imposes an obligation of providing for environmentally safe disposal of used electronic components and devices. Hence, we have been entered into a register kept by the Inspection for Environmental Protection. The crossed-out bin symbol on a product means that the product may not be disposed of to household waste containers. Recycling of waste helps to protect the environment. The user is obliged to transfer their used equipment to a collection point where all electric and electronic components will be recycled.

II. DEVICE DESCRIPTION

The EU-297v3 room regulator is intended for controlling the heating device. Its main task is to maintain the pre-set flat/floor temperature by sending a signal to the heating device (contact closing) or the main controller, which controls the actuators, when the room/floor temperature is below the pre-set value.

The EU-297v3 controller functions:

- Maintaining pre-set room temperature
- Manual mode
- Day/night mode
- Control of the floor sensor

Controller equipment:

- Touch buttons
- Front panel made of glass
- Built-in temperature sensor
- Batteries (battery version)

The EU-297v3 room regulator offers two display versions:

- standard (the data is displayed in black against white background)
- negative (the data is displayed in white against black background)

There are 2 color versions



Hardware versions:

1. **EU-297 v3 PB, EU-297 v3 PBN** – wired version, powered with two AAA 1,5V batteries
Colour versions: black or white
2. **EU-297 v3 PZ, EU-297 v3 PZN** – wired version, powered with 230V
Colour versions: black or white



III. HOW TO INSTALL THE CONTROLLER



NOTE

The device should be installed by a qualified person.

The room regulator should be connected to the heating device with a two-core cable. When connecting devices with over 1A power, a contactor must be used. Optionally, an additional sensor can be connected to the floor sensor contact - it will cause additional functions to be displayed in the controller menu.

The EU-297v3 room regulator may be used as a wall-mountable panel. In order to mount it, place the rear part of the controller in the mounting box on the wall, insert the regulator and turn it slightly.

WARNING

If pump manufacturer requires an external main switch, power supply fuse or additional residual current device selective for distorted currents it is recommended not to connect pumps directly to pump control outputs.

To avoid damaging to the device, an additional safety circuit must be used between the regulator and the pump. The manufacturer recommends the ZP-01 pump adapter, which must be purchased separately.

1. INSTALLATION OF THE REGULATOR - BATTERIES

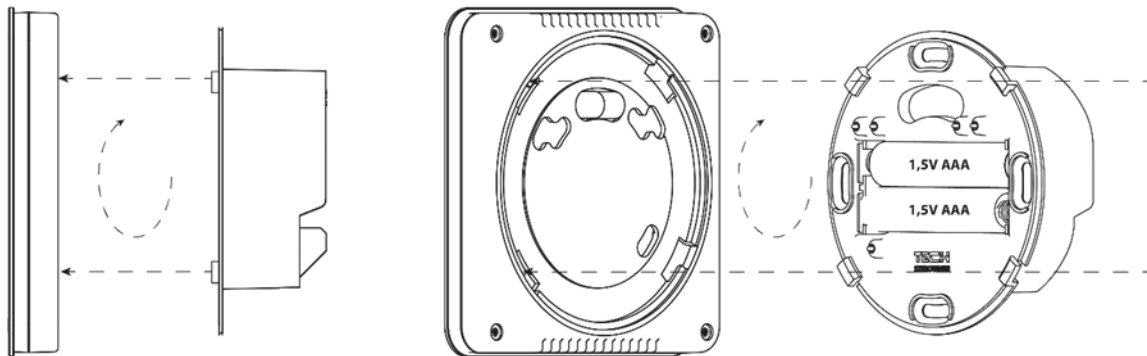
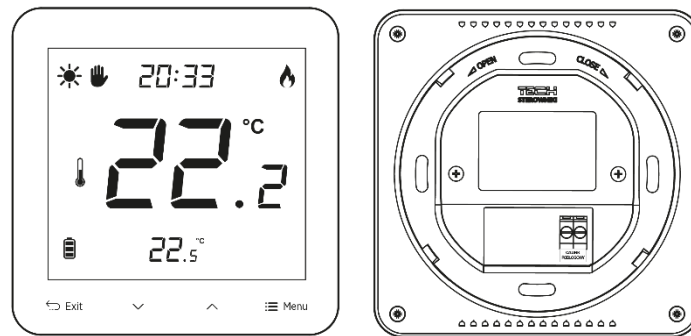
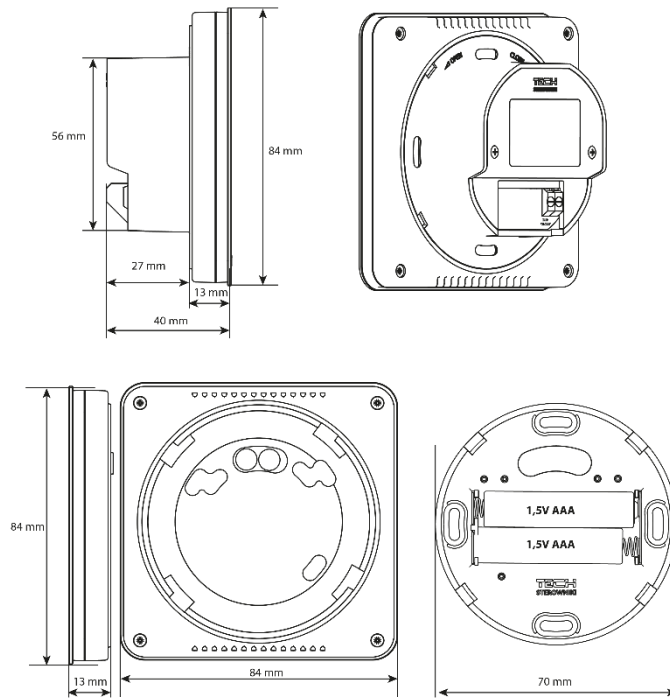

The room regulator should be connected to the heating device with a two-core cable. The cable connection of both devices is shown in the diagram below:

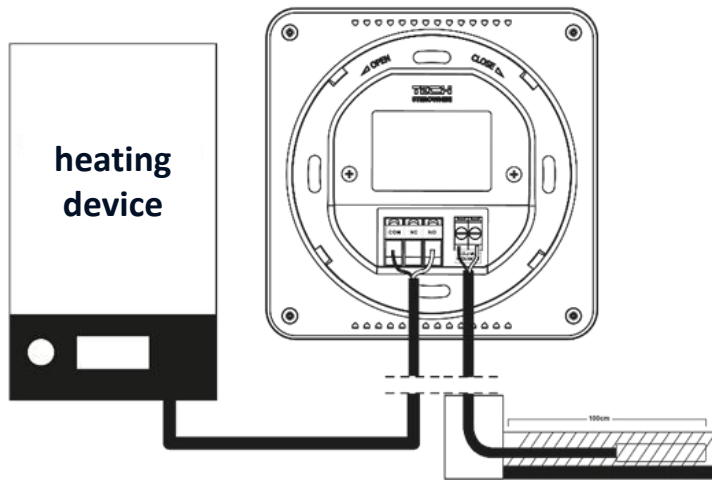

NOTE

The regulator is powered with batteries - it is recommended to check the batteries from time to time and replace them once every heating season.

2. INSTALLATION OF THE REGULATOR – POWER SUPPLY 230V

The room regulator may be used as a wall-mountable panel. In order to mount it, place the rear part of the controller in the mounting box on the wall, insert the regulator and turn it slightly.

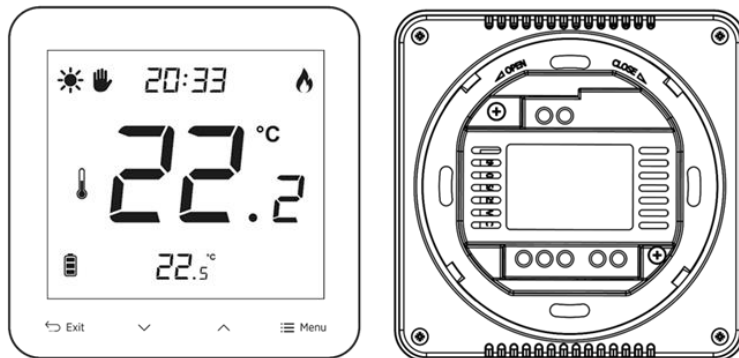

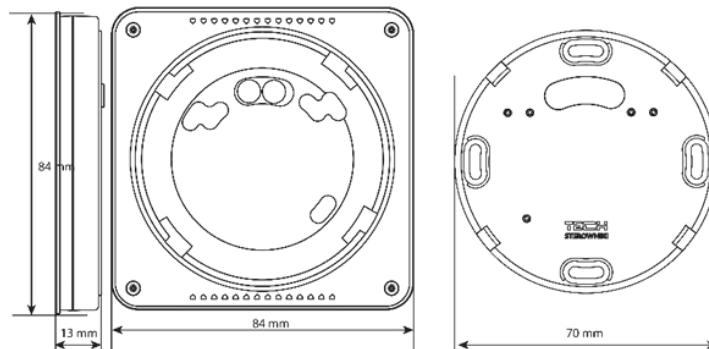
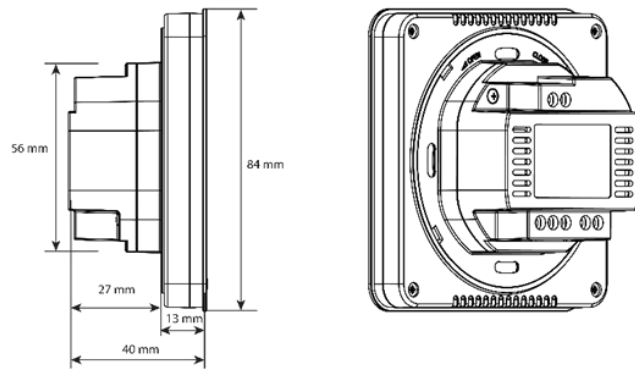
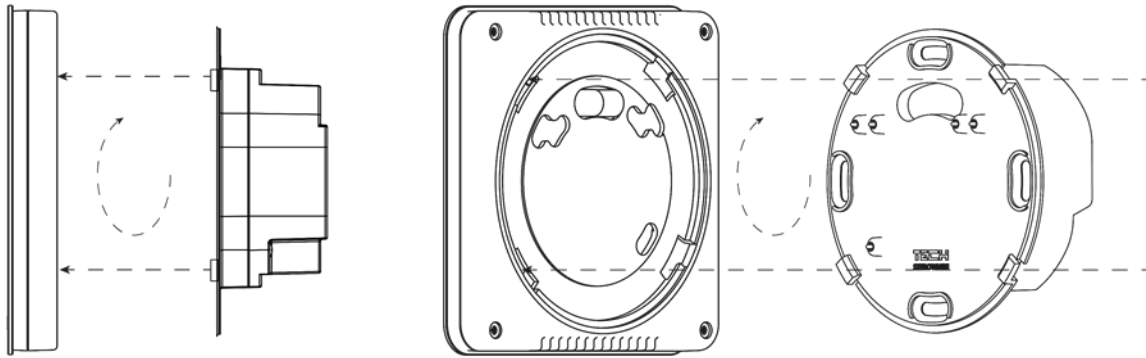

EU-297

The room regulator should be connected to the heating device with a two-core cable. The cable connection of both devices is shown in the diagram below:

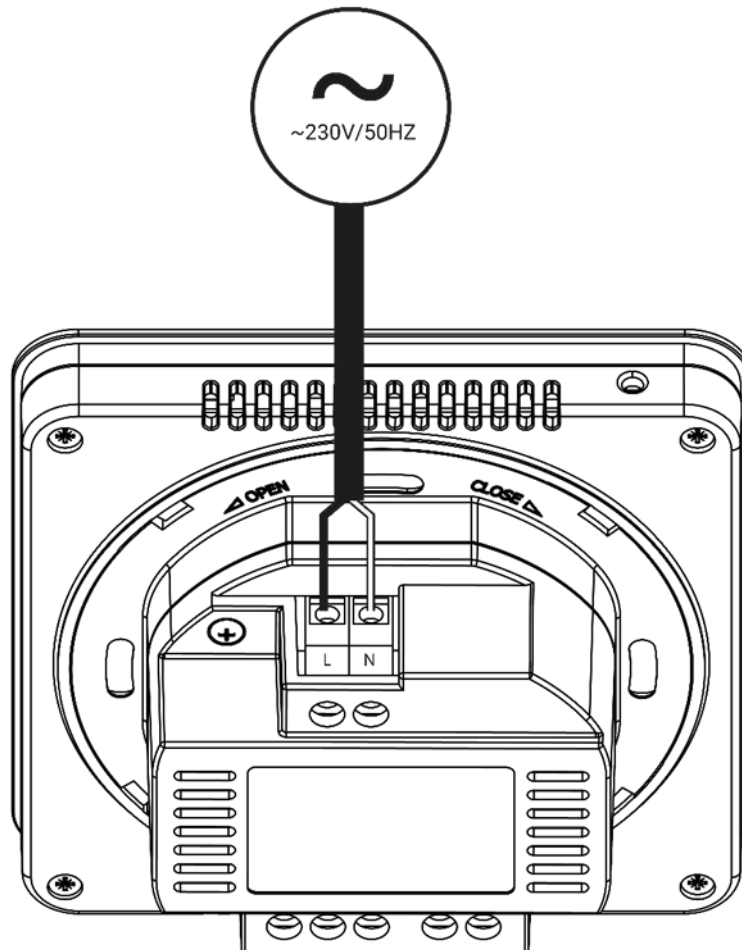
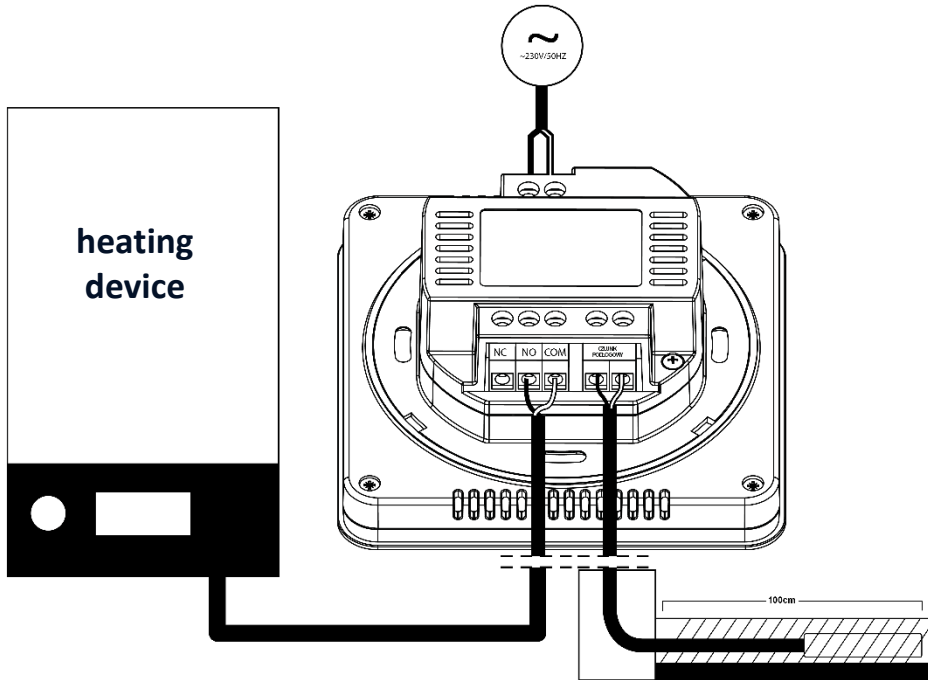

IV. FIRST START-UP

In order for the EU-297v3 controller to work properly, it is necessary to follow these steps when starting the device for the first time:

1. Insert the batteries. In order to do it, remove the controller back cover (battery-powered version).
2. Connect the controller to the heating device.
3. If you want to use a room regulator to operate the floor heating system, connect an additional sensor to the floor sensor connector.

V. HOW TO USE THE CONTROLLER

1. PRINCIPLE OF OPERATION

The EU-297v3 room regulator is designed to maintain the pre-set room temperature by sending a signal to the heating device or the main controller when the pre- set room temperature has been reached. After receiving such a signal, the heating device turns off.







NOTE

For the floor heating functions to be available, the floor sensor must be enabled in the controller menu.

2. OPERATION MODES

The room regulator may operate in one of the following operation modes:

- **Day/night mode** – In this mode the pre-set temperature value depends on the current time of the day. The user may set different temperature values for the daytime and nighttime as well as define the exact time of entering day mode and night mode. In order to activate this mode, press MENU button until one of the mode icons   appears on the main screen. The user may define the pre-set temperature and (after tapping on MENU again) the time of entering day and night mode.
- **Manual mode**  In this mode, the pre-set temperature is adjusted manually from the main screen view with the use of these buttons:  . Manual mode is activated after pressing MENU button. Once the manual mode has been activated, the previous operation mode enters 'sleep mode' until the next pre-programmed temperature change. Manual mode may be deactivated by pressing and holding EXIT button.
- **Constant mode** – In this mode, the pre-set temperature will apply all the time, regardless of the time of day.

VI. DEVICE DESCRIPTION

The user operates the device using touch buttons.

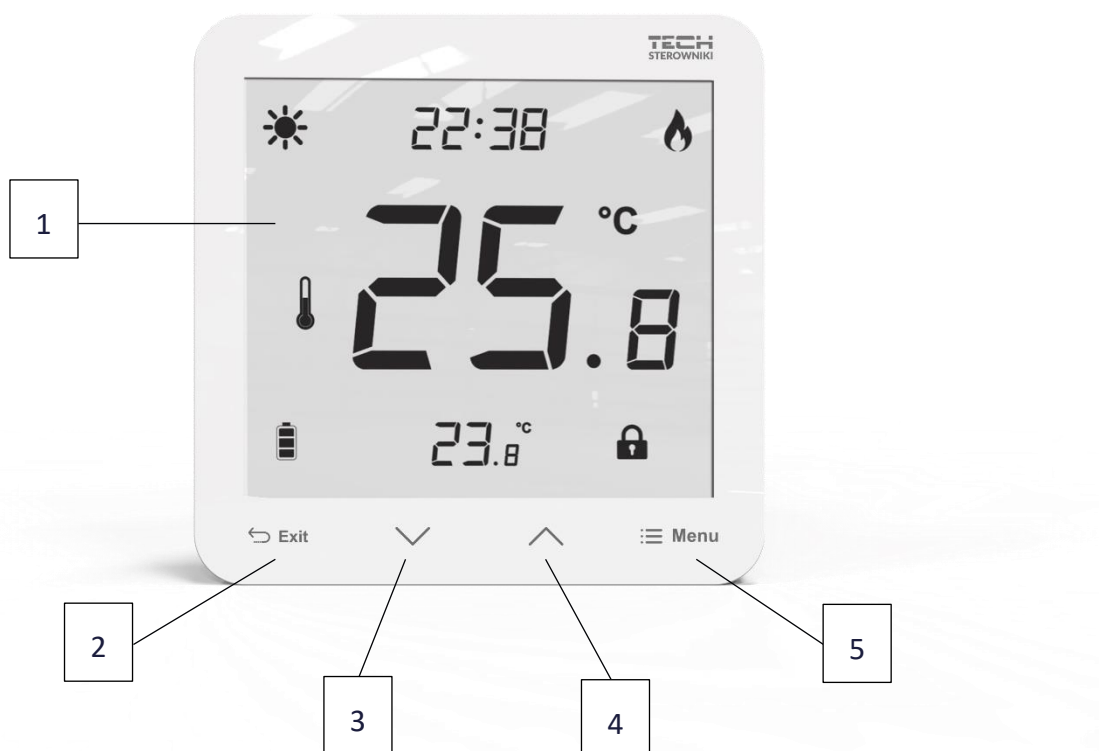

1. Display
2. **EXIT** button – press this button to display the room temperature/ floor temperature or to disable manual mode.
3. **↓** – press this button to decrease the edited value.
4. **↑** – press this button to increase the edited value.
5. **MENU** button– hold this button to enable manual mode or to set calibration. Press the MENU button to move on to edit next parameters.

1. MAIN SCREEN DESCRIPTION

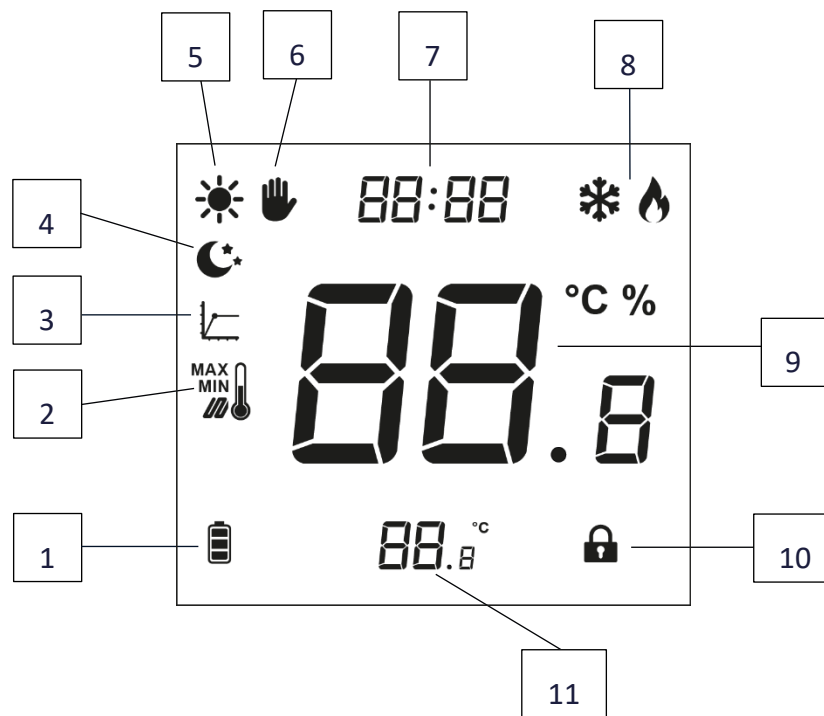

1. Battery level (battery version)
2. Maximum/minimum floor temperature - this icon is displayed only when the floor sensor is enabled in the controller menu.
3. Hysteresis
4. Night mode
5. Day mode
6. Manual mode
7. Current time
8. Cooling/heating
9. Current temperature
10. Button lock
11. Pre-set temperature

VII. CONTROLLER FUNCTIONS

The user navigates in the menu structure using touch buttons: EXIT, \vee/\wedge and MENU. In order to edit particular parameters, press MENU. By pressing MENU the user may preview the controller functions. The edited parameter is flashing. Use the buttons \vee/\wedge to change the parameter settings. Press MENU to confirm the changes and move on to edit the next parameter.

1. BLOCK DIAGRAM - MAIN MENU

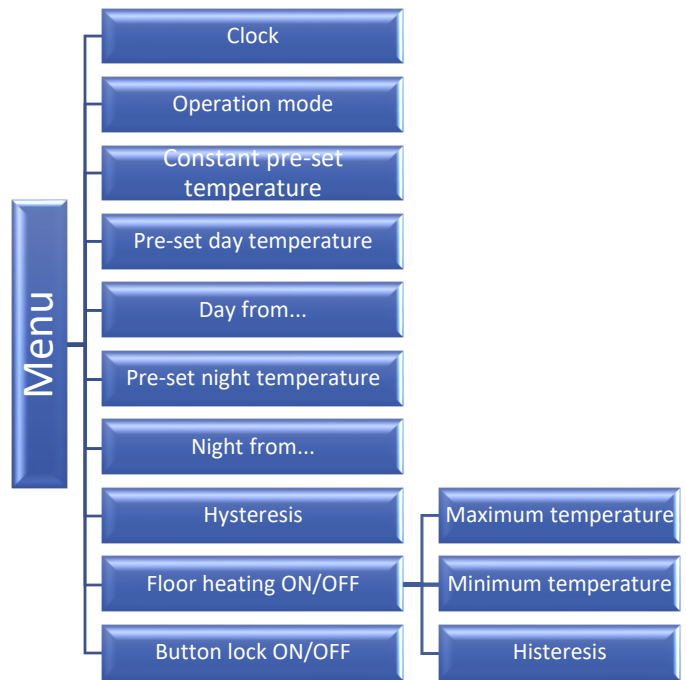

1.1. CLOCK

In order to set the time, press MENU button until the clock settings appear on the screen. The settings concern the flashing parameter.

Use \checkmark or \wedge to set the hour. Next, press MENU to move to the next parameter - minutes.

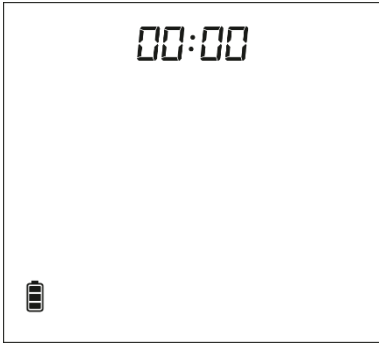

1.2. OPERATION MODE

This function enables the user to select one of the operation modes available - constant or day/night, by selecting ON or OFF. In order to do it, press the MENU button until a mode selection screen appears.

ON – this function is used to **enable constant mode** - it is possible to set constant temperature.

OFF – this function is used to disable constant mode and **enable day/night mode** - it is possible to set daytime and nighttime temperatures as well as the exact time of entering each phase.



1.3. CONSTANT PRE-SET TEMPERATURE

After selecting ON in the operation mode selection screen, a constant temperature screen will appear. Use the buttons ∇ \blacktriangle to set the temperature. The temperature will apply permanently, regardless of the time of day and the setting will be saved even after restarting the device.



1.4. PRE-SET DAY TEMPERATURE

In order to define the pre-set day temperature, press MENU button until a flashing icon  appears on the screen.

Use ∇ or \blacktriangle to set the day temperature.



1.5. DAY FROM...

This function enables the user to define the exact time of entering the day mode. To configure this parameter, press MENU until a flashing icon  appear on the screen.

Use ∇ or \blacktriangle to set the time of day mode activation.

1.6. PRE-SET NIGHT TEMPERATURE

In order to define the pre-set night temperature, press MENU button until a flashing icon  appears on the screen.

Use ∇ or \blacktriangle to set the night temperature.



1.7. NIGHT FROM...

This function enables the user to define the exact time of entering the night mode. To configure this parameter, press MENU until a flashing icon  appear on the screen.

Use ∇ or \blacktriangle to set the time of night mode activation.

1.8. HYSTERESIS

Room temperature hysteresis defines the pre-set temperature tolerance in order to prevent undesired oscillation in case of small temperature fluctuation (within the range of 0,2 - 5°C).



Example:

Pre-set temperature : 23°C

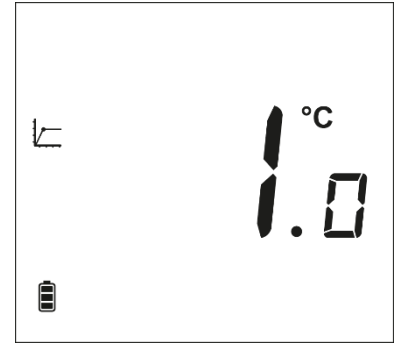

Hysteresis: 1°C

The room regulator reports that the temperature is too low when the room temperature drops to 22 °C.







In order to set the hysteresis, press MENU until a flashing icon  appears on the screen. Use  or  to set the desired hysteresis value.

1.9. FLOOR HEATING ON/OFF

This function is used to enable (ON) or disable (OFF) the underfloor heating, with the use of  .

When the underfloor heating is enabled (), the user may configure the following parameters:

- Maximum temperature - in order to set the maximum floor temperature, press MENU until the floor heating icon appears on the screen. Next, use  or  to enable the heating, and then use the same buttons to set the maximum temperature.
- Minimum temperature - in order to set the minimum floor temperature, press MENU until the floor heating icon appears on the screen. Next, use  or  to enable the heating, and then use the same buttons to set the minimum temperature.

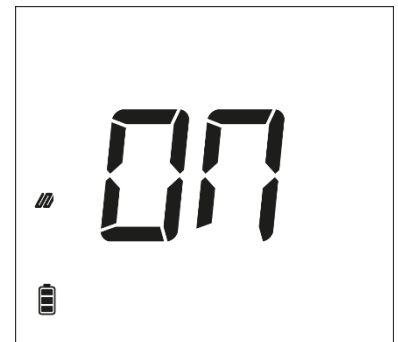

- Hysteresis - underfloor heating hysteresis defines the tolerance for the maximum and minimum temperature. The settings range is from 0,2°C to 5 °C.

If the floor temperature exceeds the maximum temperature, the underfloor heating will be disabled. It will be enabled only after the temperature has dropped below the maximum floor temperature minus the hysteresis value..

Example:

Maximum floor temperature - 33°C

Hysteresis- 2°C

When the floor temperature reaches 33°C, the underfloor heating will be disabled. It will be activated again when the temperature drops to 31°C.

If the floor temperature drops below the minimum temperature, the underfloor heating will be enabled. It will be disabled after the floor temperature has reached the minimum value plus the hysteresis value.



Example:

Minimum floor temperature - 23°C

Hysteresis - 2°C

When the floor temperature drops to 23°C, the underfloor heating will be enabled. It will be disabled when the temperature reaches 25°C.

Example:

Minimum floor temperature - 23°C

Hysteresis - 2°C

When the floor temperature drops to 23°C, the underfloor heating will be enabled. It will be disabled when the temperature reaches 25°C.

1.10. BUTTON LOCK ON/OFF

It is possible to activate button lock. In order to do it, press the MENU button until the icon  appears on the screen and select ON. In order to unlock the buttons, press and hold any button.

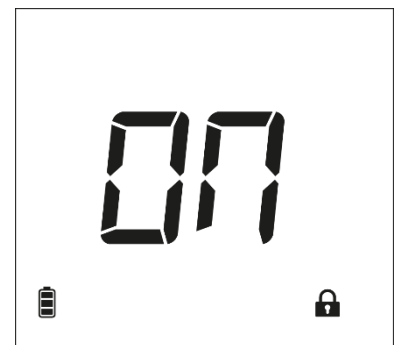



2. MENU BUTTON FUNCTIONS

By holding the MENU button the user may enter particular functions in the Menu.

2.1. COOLING/HEATING

This icon informs about the room heating or cooling to reach the pre-set temperature. These messages are displayed alternately: cooling or heating.

Choose the working mode:

- heating 
- cooling 

Default working mode is heating.



ATTENTION!

INCORRECT MODE FUNCTION MAY RESULT IN REVERSE OPERATION OF THE REGULATOR!

2.2. BUILT-IN SENSOR CALIBRATION

Calibration should be performed while mounting or after it has been used for a long time, if the room temperature measured by the sensor differs from the actual temperature. Calibration setting range is from -9,9 to +9,9 °C with the accuracy of 0,1°C.

To calibrate the built-in sensor, press the MENU button until the temperature sensor calibration screen appears. Use the buttons \checkmark \wedge to set the desired correction. To confirm, press the MENU button (confirm and go on to edit the next parameter).

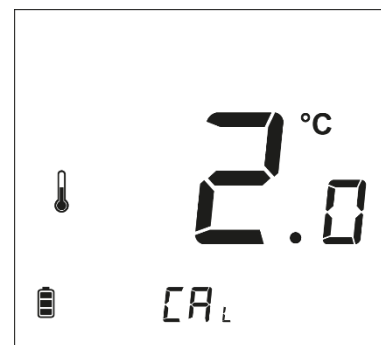

2.3. FLOOR SENSOR CALIBRATION

Floor sensor calibration (an additional icon is displayed: ) should be performed if the floor temperature measured by the sensor differs from the actual temperature. Calibration setting range is from -9,9 to +9,9 °C with the accuracy of 0,1°C.

To calibrate the built-in sensor, press the MENU button until the floor sensor calibration screen appears. Use the buttons \checkmark \wedge to set the desired correction. To confirm, press the MENU button (confirm and go on to edit the next parameter).



2.4. SOFTWARE VERSION

After pressing the MENU button the user may check the software version number. The number is necessary while contacting the service staff.



2.5. DEFAULT SETTINGS

This function is used to restore factory settings. In order to do it, change the flashing digit 0 to 1.



VIII. TECHNICAL DATA

EU-297B v3	
Temperature adjustment range	5°C - 35°C
Power supply	2xAAA 1,5V batteries
Measurement error	+/- 0,5°C
Potential-free cont. nom. out. load	230V AC / 0,5A (AC1) * 24V DC / 0,5A (DC1) **

EU -297Z v3	
Temperature adjustment range	5°C ÷ 35°C
Power supply	230V ± 10% / 50Hz
Max. power consumption	0,5W
Measurement error	± 0,5°C
Potential-free cont. nom. out. load	230V AC / 0,5A (AC1) * 24V DC / 0,5A (DC1) **

* AC1 load category: single-phase, resistive or slightly inductive AC load.

** DC1 load category: direct current, resistive or slightly inductive load.

TECH CONTROLLERS

EU Declaration of conformity

Hereby, we declare under our sole responsibility that **EU-297 v3** manufactured by TECH STEROWNIKI II Sp. z o.o., headquartered in Wieprz Biała Droga 31, 34-122 Wieprz, is compliant with Directive **2014/35/EU** of the European Parliament and of the Council of 26 February 2014 on the harmonisation of the laws of Member States relating to **the making available on the market of electrical equipment designed for use within certain voltage limits** (EU OJ L 96, of 29.03.2014, p. 357), **Directive 2014/30/EU** of the European Parliament and of the Council of 26 February 2014 on the harmonisation of the laws of Member States relating to **electromagnetic compatibility** (EU OJ L 96 of 29.03.2014, p.79), Directive **2009/125/EC** establishing a framework for the setting of ecodesign requirements for energy-related products as well as the regulation by the MINISTRY OF ENTREPRENEURSHIP AND TECHNOLOGY of 24 June 2019 amending the regulation concerning the essential requirements as regards the restriction of the use of certain hazardous substances in electrical and electronic equipment, implementing provisions of Directive (EU) 2017/2102 of the European Parliament and of the Council of 15 November 2017 amending Directive 2011/65/EU on the restriction of the use of certain hazardous substances in electrical and electronic equipment (OJ L 305, 21.11.2017, p. 8).

For compliance assessment, harmonized standards were used:

PN-EN IEC 60730-2-9:2019-06, PN-EN 60730-1:2016-10

EN IEC 63000:2018 RoHS.

Wieprz, 30.11.2022

Paweł Jura

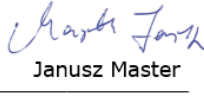
Janusz Master

Prezesa firmy

**TECH
TECH
CONTROLLERS**

Central headquarters:

ul. Biała Droga 31, 34-122 Wieprz

Service:

ul. Skotnica 120, 32-652 Bulowice

phone: **+48 33 875 93 80**

e-mail: **serwis@techsterowniki.pl**

www.tech-controllers.com